

SNF Report No. 23/08

REFINERY OPTIMIZATION PLATFORM - A USER'S MANUAL

Version 1.0

by

David Bredström

Patrik Flisberg

Linda Rud

Mikael Rönnqvist

SNF project no 7985

"Collaboration StatoilHydro"

The project is funded by StatoilHydro

INSTITUTE FOR RESEARCH IN ECONOMICS AND BUSINESS ADMINISTRATION
BERGEN, NOVEMBER 2008

© Dette eksemplar er fremstilt etter avtale med KOPINOR, Stenergate 1, 0050 Oslo. Ytterligere eksemplarfremstilling uten avtale og i strid med åndsverkloven er straffbart og kan medføre erstatningsansvar.

ISBN 978-82-491-0600-4 - Print version
ISBN 978-82-491-0601-1 - Online version
ISSN 0803-4036

Abstract

This is a manual for the Refinery Optimization Platform ROP which is a flexible platform for studying refinery production planning. The user can model the overall refining process in a multi-periodic setting, with linear and nonlinear representation of the refinery processes. All input and output is communicated via an Excel sheet, where the user can define a general refining process together with required output reports. ROP enables the user to study the planning problem by experimenting with alternative modeling approaches and restrictions. A case study with input data and results is presented.

Contents

1	INTRODUCTION	1
2	OIL REFINERY BASICS	2
2.1	Refinery Flow Chart	2
2.2	Refinery Output	3
2.2.1	Refinery Products	4
2.2.2	Quality attributes	5
2.3	Refinery Input	7
2.4	Distillation Units	7
2.5	Processes	8
2.6	Blending and Storage	10
3	CASE EXAMPLE	11
3.1	Input	11
3.2	Demand	12
3.3	Distillation Units	12
3.4	Processing Units	14
3.4.1	Reformer (RF)	14
3.4.2	Catalytic Cracker (CC)	15
3.4.3	Hydrotreater (HT)	16
4	NETWORK SHEET	18
4.1	Tables of Network Nodes and Quality Attributes	18
4.1.1	Table network_set_Oil_in	18
4.1.2	Table network_set_CDUs	19
4.1.3	Table network_set_processes	19

4.1.4	Table network_set_components	20
4.1.5	Table network_set_products	21
4.1.6	Table network_set_splits	22
4.1.7	Table network_set_qualities	23
4.2	Table network_set_arcs	23
4.3	Tables of Run Options	26
4.3.1	Table Parameters	26
4.3.2	Table AMPL_options	26
4.3.3	Table Solver_options	26
5	SUPPLYDEMAND SHEET	29
5.1	Table Supply	29
5.2	Table Demand	30
6	INITIAL VALUES SHEET	33
6.1	Table Initial_supply	33
6.2	Table Initial_component	34
7	CDUDEFINITIONS SHEET	36
7.1	Table CDU_Exchange	36
7.2	Table CDU_capacities	37
8	PROCESS_DEFINITIONS SHEET	39
8.1	Table Process_definition	39
8.2	Table Process_properties	41
9	SOLVING THE OPTIMIZATION PROBLEM	44
10	OUTPUT AND REPORT GENERATION	45

List of Tables

1	Specifications for the demand of products for the case example.	12
2	The yield pattern for the output from the AD unit for the case example.	12
3	Possible destinations for the output flow from the AD unit for the case example.	13
4	Density (lb/bbl) for relevant output from the AD unit for given input in the case example.	13
5	Sulphur content (lb/bbl) for relevant output from the AD unit for possible input in the case example.	13
6	Clear research octane for relevant output from the AD unit for possible input in the case example.	14
7	Vapour Pressure (mm Hg) for relevant output from the AD unit for possible input in the case example.	14
8	The fractions of output from the reformer.	14
9	Possible destinations for the output from the reformer.	15
10	Quality transformations in the reformer.	15
11	Output fractions from the catalytic cracker.	15
12	Possible destinations for the outputs from the catalytic cracker.	16
13	Quality transformations in the catalytic cracker.	16
14	Output fraction from the hydrotreater.	16
15	Possible destinations for the outputs from the hydrotreater.	17
16	Quality transformations in the hydrotreater.	17
17	The table <i>network_set_Oil_in</i> in the <i>Network</i> sheet for the case example.	19
18	The table <i>network_set_CDUs</i> in the <i>Network</i> sheet for the case example.	19
19	The table <i>network_set_processes</i> in the <i>Network</i> sheet for the case example.	20
20	The table <i>network_set_components</i> in the <i>Network</i> sheet for the case example.	21
21	The table <i>network_set_products</i> in the <i>Network</i> sheet for the case example.	22
22	The table <i>network_set_splits</i> in the <i>Network</i> sheet for the case example.	23
23	The table <i>network_set_qualities</i> in the <i>Network</i> sheet for the case example.	23
24	The table <i>network_set_arcs</i> in the <i>Network</i> sheet for the case example.	27

25	The table <i>Parameters</i> in the <i>Network</i> sheet for the case example.	28
26	The table <i>AMPL_options</i> in the <i>Network</i> sheet for the case example.	28
27	The table <i>Solver_options</i> in the <i>Network</i> sheet for the case example.	28
28	The table <i>Supply</i> in the <i>SupplyDemand</i> sheet for the case example.	30
29	The table <i>Demand</i> in the <i>SupplyDemand</i> sheet for the case example.	32
30	The table <i>Initial_supply</i> in the <i>Initial Values</i> sheet for the case examples.	34
31	The table <i>Initial_component</i> in the <i>Initial Values</i> sheet for the case example.	35
32	The table <i>CDU_Exchange</i> in the <i>CDUDefinitions</i> sheet for the case example.	37
33	The table <i>CDU_capacities</i> in the <i>CDUDefinitions</i> sheet for the case example.	38
34	The table <i>Process_definition</i> in the <i>Process_definition</i> sheet for the case example.	41
35	The table <i>Process_properties</i> in the <i>Process_definition</i> sheet for the case example.	43
36	The table <i>Variables_read</i> in the <i>Variable_read</i> sheet for the case example.	44
37	Produced volumes of the different products in the solution to the case example.	47
38	Data for the utilized oils in the solution to the case example.	47
39	Data for the outputs from the CDU for the solution to the case example.	47
40	Data for the output from the processes for the solution to the case example.	48
41	Data for stored components for the solution to the case example.	48
42	Blending information for the solution to the case example.	49

1 INTRODUCTION

The Refinery Optimization Platform ROP is a flexible platform for studying the planning problem of a refinery. The planner faces a variety of decisions, e.g. which products to sell, purchase and storage of crude oil, operation levels of various processing units, storage and blending of components to products, etc. The complexity of the optimization problem of the refinery lies in joint-production, combined with linear and nonlinear interdependencies. Within the ROP platform the user may model the overall refining process in a multi-periodic setting, with linear and nonlinear representation of the refinery process. All user input and output is communicated via Excel, where the user is flexible in defining the refining process, and the required reports. This enables the user to study the optimization problem by experimenting with alternative modeling approaches. Underlying the platform is a general mathematical model of the refinery process, implemented in the modeling language Ampl, see [5], and using several commercial solvers for the linear and nonlinear optimization.

Before going into details of the ROP platform, we give a brief account of the refinery process in Chapter 2. Chapter 3 presents a simplified refinery model to be used as a case example. Chapters 4-8 review the excel input sheets of ROP; - network specification in Chapter 4, - specification of supply and demand in Chapter 5, - specification of initial storage of crude oil and components in Chapter 6, - CDU transformation in Chapter 7, and - process characteristics in Chapter 8. Chapter 9 reviews issues of solving the overall optimization problem, while output and report generation is the theme of Chapter 10.

2 OIL REFINERY BASICS

Nearly all crude is refined, as crude oil by itself only can be used as a fuel. The refinery basically transforms crude oil into several different oil and gas products with different physical and chemical characteristics. These products are used for transport and fuels, and for the manufacture of plastics, fibres, synthetic rubbers, etc. A refinery is made up of several distinct parts:

-Various processing units, which separate crude oil into different fractions or cuts, upgrade and purify some of these cuts, and convert heavy fractions to light fractions.

-Utilities, which are the systems and processes that provide the refinery fuel, flaring capability, electricity, steam, cooling water, effluent treatment, fire water, sweet water, compressed air, nitrogen, etc.

-The tankage area where all crude, finished products and intermediates are stored prior to usage or disposal.

-Facilities for receipt of crude oil, and blending and dispatch of finished products.

The focus of the ROP platform is on optimal refinery operations with optimal plans for e.g. crude oil purchase, running processes and sales. For users not familiar with the production process of refineries, this chapter shortly reviews some refinery basics. The chapter is based on [3], which gives an overview of the refining industry. Other references are for example [6] and [8]. Section 2.1 briefly gives an example of a refinery showing a simplified flow chart of the Norwegian Mongstad refinery, with its processing units and main flows. Section 2.2 gives examples of refinery products and their quality attributes. Section 2.3 comments refinery input. Sections 2.4 and 2.5 look into the main processing units of a refinery, respectively distillation units and other processing units. Blending and storage is the topic of Section 2.6.

2.1 Refinery Flow Chart

To give an overall view of a refinery, a refinery flow chart is useful to map the main units and flows. An example of a refinery is given in Figure 1 which shows a simplified flow chart diagram of the Norwegian refinery *StatoilHydro Mongstad*. The main input to any refinery is crude oil, and the first stage in the refining process is usually the distillation of the crude oil. Through distillation, crude oil is separated into different fractions. Only a smaller part of the output from the distillation process can be directly used as components in blending marketable products. The further refining process thus consists of a complex series of interconnected processing steps in a variety of processing plants which separate, chemically rearrange (reform, isomerize, convert, or crack) and purify or sweeten the fractions from initial distillation. The last step of the refining process is the blending of the produced components to form the required products. The necessary processing steps depend upon the physical and chemical properties of the crude oil, as well as the quality specifications of the final customer products.

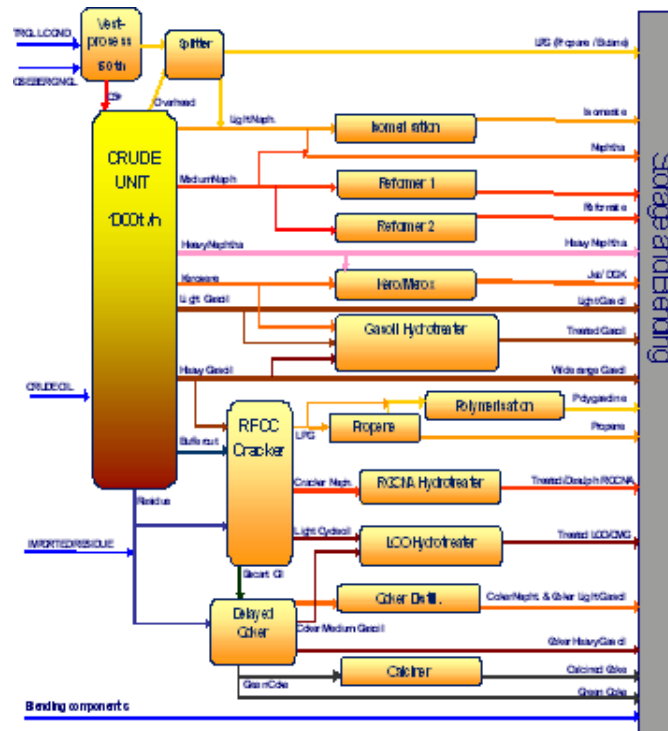

Figure 1: An example of a refinery flow chart from StatoilHydro Mongstad.

In the ROP platform a detailed flow chart showing the structure of the refinery model is defined in the **Network** sheet, described in Chapter 4. Here all the nodes (input, CDUs, processes, components, products, and split nodes) and qualities in the network are listed in tables **Oil_in**, **CDUs**, **Processes**, **Components**, **Products**, **Splits**, and **Qualities**. All flows, for example, from input to CDUs, from CDUs to processes, from processes to components, etc., are described in the **Arc** table. In solving the problem in ROP, a refinery flow chart is automatically generated, showing the optimal flows and quality specifications.

2.2 Refinery Output

Refinery products cover a large range of products for a large range of applications. *Transport fuels* are e.g. motor gasoline, jet fuel, automotive gas oil and LPG. *Heating fuel* products include LPG, kerosene, heating gas oil, heavy fuel oil, petroleum coke and pitch. In addition there is a large range of *non-energy products* as bitumen, lubricating oils, white spirit, lighting kerosene, process oils, solvents, slack wax, refined waxes, etc., while products like naphtha, LPG and gas oil are important *feedstocks for petrochemicals*. For each product type, products are differentiated as to quality requirements. In Section 2.2.1, we review some of the main refinery products and their main indicators of quality, while Section 2.2.2 briefly explains some of the quality attributes.

2.2.1 Refinery Products

The products produced in the refining process form a wide range of petrochemical products, which are classified in a variety of ways. Here we will give examples of product types and some of their main quality attributes.

Motor Gasoline, or petrol, is the fuel for spark ignition engines used in small vehicles. Additives are often used to enhance performance and provide protection against oxidation and rust formation. Gasoline is one of the most high-valued products due to high margins and large volumes. Important specifications relate to the octane number, vapour pressure, density, and sulphur content.

Automotive Gas Oil, also called DERV (Diesel Engine Road Vehicles), is the fuel mainly for diesel engines. Main specifications include density, the cetane index, cloud point, sulphur content, and appearance.

Heating Gas Oil is used for domestic heating, and also in small marine engines and on oil rigs. Heating oil has very similar characteristics as diesel, with the main quality attributes of density, cloud point, cetane index, sulphur content, and appearance. In addition specifications of a maximum viscosity is necessary to ensure that the product can flow correctly in heating system installations.

Heavy Fuel Oil is mostly an industrial fuel used in the electricity generation sector, or as fuel for generation of steam for large marine steam-turbines in ocean-going vessels. Some important specifications relate to viscosity and sulphur content.

Jet Fuel is the fuel used in jet and turboprop aviation engines. Jet fuel is the principal application for the distillate product kerosene, which is an intermediate between naphtha and gas oil. Among the most important characteristics controlled are: cold temperature performance, density, sulphur content, smoke point, and the luminometer number.

Liquefied Petroleum Gases (LPG) consists of various forms of propane and butane. Propane and butane sold commercially are usually mixtures rather than pure products. LPG has the advantage of being a clean fuel, and is very flexible in its use, e.g. for cooking, district heating, as a feedstock in petrochemicals manufacture, and butane, as a good motor gasoline component.

Naphtha is a distillate between LPG and kerosene, and ranges from light distillate naphtha and heavier distillate naphtha. The paraffinic part of the light distilled naphtha is a valuable feedstock for the manufacture of olefins (ethylene, propylene, etc.), and is applied in the production of e.g. plastics, PVC, neoprene, detergents, etc. The non-paraffinic part of light naphtha plus the heavier distillate naphtha is used in the catalytic reforming unit to produce reformate which is an important gasoline component. Reformate also contains aromatics

which are used for the manufacture of polystyrene, resins, solvents, plasticizers and various types of film. Also, solvents like benzene, toluene and xylene may also be extracted from aromatics.

Petrochemical feedstock Many products derived from crude oil, such as ethylene, propylene, butylenes, and isobutylene, are used as petrochemical feedstock in the production of e.g. plastics, synthetic fibres, synthetic rubbers.

Lubricants are produced in special refining processes. Additives such as demulsifiers, antioxidants, and viscosity improvers are blended in to meet the specifications required for motor oils, industrial greases, lubricants, and cutting oils.

*In the ROP platform refinery output is described in the **Demand** table of the **SupplyDemand** sheet described in Section 5.2. Here each product is described in terms of demand and selling prices, as well as maximum and minimum restrictions on the relevant quality attributes of each product. The specification of possible blending components to obtain the products is given by the flow specification in the **Arc** table of the **Network** sheet, see Section 4.2.*

2.2.2 Quality attributes

There are a large number of quality attributes. To provide an insight as to the nature of quality specifications, we briefly review some of the main attributes.

Octane number: This is a measure of the gasoline's resistance to auto-ignition (or self-ignition). Auto-ignition puts abnormal stress on a petrol engine, risking engine damage over time or even breakdown. The product's resistance to auto-ignition is managed by the accurate blending of different components produced in the refining processes. Octane numbers are measured in two ways. Research Octane Number (RON) measures engine performance at low speed and at low temperature; Motor Octane Number (MON) is relevant to engine performance at high engine speed at high temperatures. A high octane number means that the engine can have a high compression ration, which means higher engine efficiency.

Vapour Pressure: This is the pressure exerted by the vapour emitted from the fuel. A minimum vapour pressure is required to ensure good cold starting characteristics, but too high a vapour pressure increases evaporation from the fuel tank and therefore causes unwanted emissions of pollutants, and safety concerns in storage. Vapour pressure is mainly controlled by varying the butane content of the product.

Density: The calorific value of fuel depends on its weight, thus density determines the amount of energy present in a given volume, since: $\text{volume} * \text{density} = \text{weight}$. Also, even when the price is quoted by weight, it is subject to a price correction against a standard density, because sales to the end consumer is always by volume.

Sulphur Content: The maximum allowed sulphur content has gradually been lowered to reduce environmentally harmful emissions. Reductions in maximum sulphur levels are expensive for the refiner, requiring either the purchase of more expensive low sulphur crude oil, or adjustments in the refining processes.

Cetane Index: In a diesel engine, the air in the cylinder is compressed so as to raise the temperature to a level at which the gas oil ignites spontaneously when injected. The susceptibility to auto-ignition is measured by the cetane index. A higher centane-index implies less resistance to auto-ignition, and thus a higher quality diesel fuel. In the refining process, additives are used to improve the centane index.

Cloud Point: This is the temperature at which a cloud can be observed in the in the liquid product caused by the formation of the first wax crystals. Cloud point is one of the tests on the cold temperature performance of diesel. Others tests are e.g. Cold Filter Plugging Point (CFPP), and Pour Point. Before the only method of improving cold temperature performance was through the selection of blending components. Now new additives have become widely used, allowing some of the heavier components to be retained in the blend, and thereby also giving the benefit of avoiding loss of yield to heavier, less valuable products.

Appearance: There are always small quantities of water present in distillate products, and if too much water remains in solution, diesel fuel can become hazy when cooled. In colder areas, this can lead to blockages in fuel lines or fuel filters. The correct appearance of diesel and other fuels at a specified temperature is used as an indication of the absence of excessive water contamination. In this companies often set individual measures to ensure the correct appearance of "clear and bright".

Viscosity: The specifications of a maximum viscosity is to ensure that the product can flow correctly in e.g. heating system installations.

Smoke point: A high aromatics content is harmful. Smoke point is used to achieve the necessary control of aromatic content, e.g. in aviation fuel. The smoke point is the maximum height to which the flame in a standard paraffin wick lamp can be raised without the formation of smoke.

Luminometer number: This is a more technically sophisticated way of controlling the quality of the flame produced when the fuel burns, and is also an indirect control of the aromatics content.

*In the ROP platform the set of all quality attributes is also listed in the **Network** sheet as described in Section 4.1. The qualities of CDU flows, as well as resulting transformations in processes are modelled in the **CDUDefinitions** sheet, cf. Chapter 7 and the **ProcessDefinitions** sheet, cf. Chapter 8.*

2.3 Refinery Input

There are as many different crude oils as there are different oil fields. Crude oil is a mixture of hydrocarbons (molecules of carbon and hydrogen atoms), and normally also contains impurities (sulphur, metals, nitrogen). The hydrocarbon molecules range one to more than 50 carbon atoms, where the same combination of atoms can be arranged in different ways to give quite different molecular structures. With different proportions of different molecules, and with variations in the percentage of impurities, each crude oil has its own specific physical and chemical properties. As oil fields gradually become exhausted, the quality of blended crudes can gradually change with changes in the proportion of the crude oils in the blend. The full quality specification for each crude at time of production is contained in an "assay", which is regularly updated. Some important quality specifications are:

Relative density: For crude oil this is often reported in terms of degrees API (American Petroleum Institute), obtained from the following formula: $^{\circ}API = 141.5/d - 131.5$, where d is density. A light crude oil (gravities higher than $33^{\circ}API$) contains a higher proportion of the smaller molecules that make up the light and middle distillates. A heavy crude oil (gravities less than $22^{\circ}API$) contains a high proportion of the very large molecules, as present in fuel oil.

Sulphur content: Sweet (low sulphur) crudes, have less than 0.5 % wt sulphur. Medium sour crudes have between 0.5 and 1.5% wt sulphur. Sour (high sulphur) crudes have over 1.5% wt sulphur.

Crude oil is the main input to the refinery. The refinery may also import components from other refineries, supplementing the output of CDU and the other processes. In addition several chemicals may be used, as catalysts or additives; *Leaded gasoline additives*, e.g. TEL or TML, were formerly used to improve gasoline octane ratings, but are no longer in common use except in aviation gasoline; *Oxygenates*, e.g. ETBE, MTBE and TAME, are used to improve gasoline octane ratings and reduce carbon monoxide emissions; *Caustics* are added to desalt water to neutralized acids and reduce corrosion, or desalt crude oil to reduce the amount of corrosive chlorides in the tower overheads; *Sulfuric acid and hydrofluoric acid* are used primarily as catalysts in alkylation processes.

*In the ROP platform refinery input is defined in the **Supply** table of the **SupplyDemand** sheet described in Section 5.1. Here each input is described in terms of buying prices, and quality specifications. The use/destination of inputs is defined in the flow specification of the **Arc** table in the **Network** sheet, cf. Section 4.2.*

2.4 Distillation Units

The first step in the refining procedure is normally the distillation of crude oil where crude oil is separated into different fractions. There are two main types of distillation units:

Atmospheric crude oil distillation unit (CDU): The CDU is often the largest unit in the refinery. The CDU separates crude oil into different fractions according to their boiling ranges. The crude oil is pumped from its storage tank, heated, and enters the distillation column at a temperature of around $360\text{ }^{\circ}\text{C}$ and a pressure of about 2 bar, at which gaseous fractions rise as vapours up the column. There are temperature differences along the column, with higher temperatures at the bottom, and declining temperatures towards the top. The vapours pass up the tower through horizontal trays. When a substance in the vapour reaches a height where the temperature of the column is equal to that substance's boiling point, it condenses to form a liquid. The substances with the lowest boiling point condense at the highest point in the column, and the substances with higher boiling points condense lower in the column. This system, known as fractional distillation, thus separates the crude oil in different cuts and fractions drawn off at different rates and at different levels on the column. From the lightest to the heavier fractions, some of the main cuts are propane, butane, light naphtha, heavy naphtha, kerosene, light gas oil, heavy gas oil, buffercut, and atmospheric residue.

Vacuum distillation units (VDU): Atmospheric distillation is limited to the separation of fractions boiling up to $360\text{ }^{\circ}\text{C}$. Distillation under vacuum conditions lowers the boiling points so that the atmospheric residue can be separated into vacuum residue and lighter cuts between short residue and gas oil. These fractions are usually called vacuum distillates, vacuum gas oils or waxy distillates.

*In the ROP platform the distillation units are described in the **CDUdefinitions** sheet described in Chapter 7. In the **CDU_exchange** table (Section 7.1) inputs and outputs to the CDU are described, along with volume and quantity relationships for all flows. In the **CDU_capacities** table (Section 7.2) capacities and variable costs of operation are defined.*

2.5 Processes

A few of the distillate products like Naphtha and Gas Oil may be directly used as blending components, however, most distillates are further treated in processes that improve or change the quality of the distillation cuts. These processes may e.g. convert or crack heavy fractions into lighter fractions, alter the hydrocarbon molecular structure of lighter cuts, remove unwanted impurities, or manufacture speciality products. Examples of processes are:

Cracker Processes: Heavier fractions are converted to lighter products through various forms of conversion processes, where the principle of the process is to "crack" heavy molecules into light molecules. The main types of crackers are:

- In **thermal crackers** the molecules are broken by heating them. The simplest cracking process, *visbreaking*, is used for the conversion of a small proportion of residue into components in the gas, naphtha and gas oil range. *Coking units* have more severe operating conditions, but break heavy molecules down to a greater extent, yielding both light products (gas, naphtha and gas oil) and a solid residue, petroleum coke, which is mainly carbon. *Delayed coking*, the most commonly used process, yields coke of a quality suitable for use as

electrodes in the manufacture for aluminium, providing that the crude oil feedstock is of the correct quality. The coke can also be used as a fuel in cement kilns or combined with coal for use in power stations. However, the light fractions produced require hydrotreatment to remove sulphur and the unstable olefins present.

- In **catalytic crackers**, the action of heat is reinforced by use of a catalyst. In the *fluid catalytic cracking (FCC) process*, the feed is first vaporized and mixed with the catalyst, after which cracking takes place and coke forms a deposit on the catalyst. The process yields several components. The propane/butane fraction can be used to produce high quality motor gasoline components, and the iso-butylene present in the butane cut is also a feedstock for production of high octane MTBE. Up to 60% of the cracked products are however low quality motor gasoline components that need further treatment. For example, after a further desulphurisation, a distillate called light cycle oil (LCO) is obtained, which is highly aromatic with a low cetane number that makes it an excellent diluent for high viscosity residues. The residue from the cracker, heavy cycle oil (HCO) or slurry oil, is also highly aromatic, though mostly with a limited use as a fuel oil component in most refineries.

- In **hydrocrackers**, the feedstock is mixed with hydrogen before being passed over one or more catalysts, and subsequently cracked. Hydrocracking then yields high quality, very low sulphur products, for example giving naphtha, middle distillates, and LPG which is a very good source of iso-butane for alkylation units. Hydrocracked naphtha is normally sent to the catalytic reformer for upgrading to a high octane motor gasoline component, and the kerosene fraction makes excellent jet fuel. The gas oil fractions, which have a very high cetane number and almost no sulphur, are important components for blending diesel.

Isomerization Unit: Isomerization is defined as a rearrangement of atoms and bonds within a molecule without any change of the molecular formula. For example, light naphtha can be used directly as petrochemical feedstock. However, it can also be used as a motor gasoline component, but has a low octane number (RON). To upgrade RON, light naphtha can be processed through an isomerization unit, which by use of a catalyst changes the molecular structure. The product from the isomerization unit (isomerate) has a better octane number than light naphtha.

Alkylation Units: In alkylation processes the structures of molecules in one fraction are rearranged to produce another. For example, in alkylation low molecular weight compounds such as propylene and butylene, may be mixed in the presence of a catalyst, giving products that are high-octane hydrocarbons used in gasoline blends to reduce knocking.

Catalytic Reforming Unit: Heavy naphtha has a very poor octane number, and is, if not upgraded, only useful as a second rate chemicals feedstock. Through the catalytic reforming unit, using catalysts as platinum and rhenium, heavy naphtha is converted to high octane "reformate", and thus an essential component for the manufacture of motor gasoline.

Hydrodesulphurisation Units: The refining process also includes units for the removal of impurities, in particular sulphur. There are a variety of processes. For example, in hydrodesulphurisation units, or hydrofiners, oil is mixed with hydrogen over a catalyst and the sulphur combines with the hydrogen to give hydrogen sulphide. Hydrofiners can also reduce the content of nitrogen impurities in a similar way, although not as effectively.

*The process outputs are used as input in further processes or as components for blending final marketable products. Through the process transformation, volume as well as qualities are transformed. In traditional linear programming methods, transformations is modelled as linear relations, while the transformation in reality may be non-linear. The ROP platform allows non-linear modelling of the process transformations of volume and quality. In the ROP platform the processing units are defined in the **ProcessDefinitions** sheet, see Chapter 8. In the **Process_definition** table (Section 8.1) inputs and outputs are described, along with volume and quantity relationships for all flows. In the **Process_properties** table (Section 8.2) the capacities and variable costs of operation are defined.*

2.6 Blending and Storage

The various processing units described above do in general not yield finished products directly. The output is in form of components, intermediates, or semi-finished products that need to be blended to give products meeting the required specifications. The objective of product blending is to allocate the available blending components in such a way as to meet product demand and their specifications at the least cost, maximizing overall profit.

An example to illustrate the blending process is that of motor gasoline which has a large number of characteristics to be controlled in the specification. Some refineries use more than 10 components, including butane, isomate, alkylate, reformate, catalytic cracked gasoline, MTBE, etc. It is essential that the product sold conforms to the requirements of the specification, but it is also important that, if possible, the product supplied is not of a higher quality than is required, because such quality give-away is simply a waste of money. Although oil refining is an continuous process, substantial tankage capacity is necessary for storage of crude oil, finished products, intermediates and product components. This storage is required both in case of unit shutdowns and to provide flexibility in the manufacturing process. Nevertheless, while refiners can always benefit from tankage availability, managers have to balance the benefit it gives against its operating cost and against the cost of holding extra stock.

*In the ROP platform processed components and inputs are blended into final products to maximize the objectives of the overall optimization problem. The allowable components to form the various end products are described in the **network_set_arcs** table of the **Network** sheet, described in Section 4.2. Data on initial storage is given in the **Initial Values** sheet. Initial storage of oil and other purchased inputs is defined in the **Initial_supply** table, see Section 6.1. The initial storage of processed components is given in the **Initial_component** table described in Section 6.2. To model a multi-periodic setting, data for the relevant time-periods also have to defined in the **Supply** table, the **Demand** table, the **CDU_capacities** table, and the **Process_properties** table (see Sections 5.1, 5.2, 7.2, and 8.2). In addition the end values of input storage and component storage have to be specified in the **Initial_supply** table, and the **Initial_component** table (Sections 6.1 and 6.2).*

3 CASE EXAMPLE

As a case example we employ a modified version of the classic refinery model of 'The independent refiner' of [1]. The example models a small refinery with four processing units: an atmospheric distillation unit, a reformer, a fluid catalytic cracker, and a hydrotreating unit. The refinery produces five products: Fuel gas, Premium gasoline, Regular gasoline, Distillates, and Fuel oil. The refinery flow chart in Figure 2 illustrates the refinery complex with all units, inputs, products and flows.

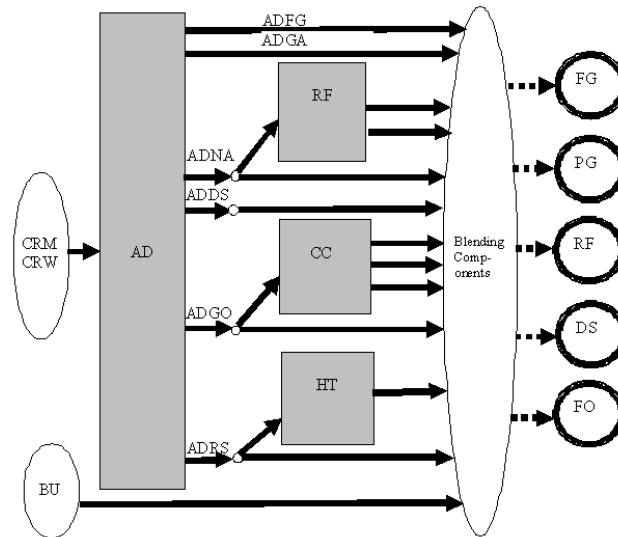

Figure 2: A refinery flow chart of the case example.

The objective of the refinery is to maximize its results. As we assume that the capacity and fixed costs are given, the refinery will maximize its net margin defined as product revenues less the variable costs of crude oil, imports, and operating costs. Below are the necessary details of this stylized refinery to form an one-period optimization problem.

3.1 Input

The refinery purchases crude oil from two different sources, known as Mid Continent (CRM) at 7.5 \$ per barrel (\$/bbl) and West Texas (CRW) at 6.5 \$/bbl. Maximum supply of each crude oil per day is 200,000 bbl. The crude oils have different quality properties. CRM has a low sulphur content, but is high-priced. CRW is low-priced, but has a high sulphur content. In addition, one chemical additive, butane, can be used in blending gasoline (PG and RG). Introduction of butane into the gasolines greatly increases vapour pressure, and gives a slightly increased octane rating of the resulting blend, but at a high price. The refinery purchases butane (BU) at 6.75 \$/bbl. The imported butane has an octane value of 91.8 and a vapour pressure of 199.2. There is no initial storage of crude oil, butane, or any blending components.

3.2 Demand

The refinery produces five products. The four main products of Premium Gasoline (PG), Regular Gasoline (RG), Distillates (DS), and Fuel Oil (FO) are marketable. There are no restrictions on possible sales. In the original model of [1], there were no restrictions as to the minimum volume of sales, but in our model we have added that at least 30 bbl has to be sold for each of the products PG and FO. Table 1 shows the sales prices of the products, and quality specifications related to density and sulphur for PG and RG, and specifications of octane and vapour pressure for DS and FO. The fifth product is Fuel Gas (FG) which is an output of the atmospheric distiller, the reformer, and the catalytic cracker. This product cannot be used in the blending of products, however, the plant can burn FG for its thermal energy, with a internal value of 1.5 \$/bbl placed on fuel gas used for this purpose.

	Sales Price (\$/bbl)	Density (lb/bbl)	Sulphur (lb/bbl)	Clear Research Octane (RON)	Vapour Pressure (mm Hg)
PG	10.5	-	-	min 90	12.7
RG	9.1	-	-	min 86	12.7
DS	7.7	max 306	max 0.5	-	-
FO	6.65	max 352	max 3.5	-	-

Table 1: Specifications for the demand of products for the case example.

3.3 Distillation Units

The refinery has one CDU, an atmospheric distiller (AD). The input to AD is crude oil. The processing capacity of the AD unit is in total 100,000 barrels per day. The operating costs are 0.1 \$/bbl processed.

The AD unit produces six separate output flows by breaking the input crude oil into six parts; a fuel gas fraction (ADFG), a gasoline fraction (ADGA), a naphtha fraction (ADNA), a light distillates fraction (ADDS), a heavy distillates, or gas oil, fraction (ADGO), and the residuals bottoms (ADRS). The yield pattern, i.e. the fraction of each of these outflows, depends on the properties of the crude oil. For each crude oil, Table 2 shows the fraction of output to each of these categories. Note that the total output fractions from each input summarizes to 1.000. The destination of the output flows from the AD unit are given in Table 3, showing that the destinations are partly input to the processing units, and partly blending components for the final products.

	Output Fractions					
	ADFG	ADGA	ADNA	ADDS	ADGO	ADRS
Input CRM	0.029	0.236	0.223	0.087	0.111	0.314
Input CRW	0.017	0.180	0.196	0.073	0.091	0.443

Table 2: The yield pattern for the output from the AD unit for the case example.

	Destination Process (Input to Processes)			Destination Products (Blending Components)				
	RF	CC	HT	FG	PG	RG	DS	FO
Fuel gas fraction (ADFG)				x				
Gasoline fraction (ADGA)					x	x		
Naphtha fraction (ADNA)	x				x	x	x	
Light distillates fraction (ADDS)		x					x	
Heavy distillates fraction (ADGO)		x					x	x
Residuals bottoms (ADRS)			x					x

Table 3: Possible destinations for the output flow from the AD unit for the case example.

The quality of the output streams from the AD varies according to the characteristics of the crude oil input. Relevant quality specifications for each combination of input and output are shown in tables 4-7. Table 4 shows the relevant densities of the AD output, specified as to whether the input is CRM or CRW. Likewise, Table 5 shows the sulphur content, Table 6 the clear research octane number, and Table 7 vapour pressure.

	Input CRM	Input CRW
Output ADNA	272	272
Output ADDS	292	297.6
Output ADGO	295	303.3
Output ADRS	343	365

Table 4: Density (lb/bbl) for relevant output from the AD unit for given input in the case example.

	Input CRM	Input CRW
Output ADNA	0.283	1.480
Output ADDS	0.526	2.830
Output ADGO	0.980	5.050
Output ADRS	4.700	11.000

Table 5: Sulphur content (lb/bbl) for relevant output from the AD unit for possible input in the case example.

	Input CRM	Input CRW
Output ADGA	78.5	78.5
Output ADNA	65.0	65.0

Table 6: Clear research octane for relevant output from the AD unit for possible input in the case example.

	Input CRM	Input CRW
Output ADGA	18.4	18.4
Output ADNA	6.54	6.54

Table 7: Vapour Pressure (mm Hg) for relevant output from the AD unit for possible input in the case example.

3.4 Processing Units

The refinery has three processing units aside from the atmospheric distiller. These are a reformer, a catalytic cracker, and a hydrotreater. For all three, input is various streams from the atmospheric distiller.

3.4.1 Reformer (RF)

The sole input to the RF unit is ADNA. The processing capacity of the RF unit is in total 20,000 barrels input per day. The operating costs are 0.15 \$/bbl processed.

The output from the reformer is fuel gas (RFFG) and reformat for gasoline blending (RFGA). Table 8 shows the fraction of output to each of these categories. In the original model by Aronofsky et al. [1] the flow originating from each crude oil is kept track of through the processes, i.e. the model distinguishes whether the output of the reformer originates from AD-output from CRM or from CRW. In our model, the flows are mixed, and qualities accordingly updated. This necessitates a slight modification from the original model. We have here chosen to use the fractions from the CRM-flow. Note that there is a loss of 6.4 %. The destination of the output flows from the RF unit is as blending components for FG, PG, and RG, as shown in the Table 9.

	Output Fractions	
	RFFG	RFGA
Input ADNA	0.129	0.807

Table 8: The fractions of output from the reformer.

The processing units may transform the quality characteristics of the input. For the possible input-output combinations of the reforming unit, quality transformations are given in Table 10. Referring to the original example, the 60% increase in Clear Research Octane is given by the relation between the stated new octane number of 104 and the ADNA octane number of 65, i.e. a relative change of $104/65 = 1.6$, or an increase of 60%. Likewise for vapour pressure, $2.57/6.54 = 0.393$, implying a 60.7% decrease.

	Destination Products (Blending Components)				
	FG	PG	RG	DS	FO
Fuel gas fraction (RFFG)	x				
Gasoline fraction (RFGA)		x	x		

Table 9: Possible destinations for the output from the reformer.

Input	Output	Density	Sulphur Content	Clear Research Octane	Vapour Pressure
ADNA	RFFG	-	-	-	-
ADNA	RFGA	-	-	+60%	-60.7%

Table 10: Quality transformations in the reformer.

3.4.2 Catalytic Cracker (CC)

The inputs to the CC unit are the AD output flows of ADDS and ADGO. The processing capacity of the CC unit is in total 30,000 barrels input per day. The operating costs are 0.08 \$/bbl processed.

The CC unit produces three separate output flows; a fuel gas fraction (CCFG), a gasoline fraction (CCGA), and a gas oil fraction (CCGO). The yield pattern differs according to the mix of input from ADDS and ADGO. Table 11 shows the fraction of output to CCFG, CCGA, and CCGO, depending on whether the input is ADDS or ADGO. As noted above, the original example follows the flow from each crude oil through the processes. In our model, the flows are mixed, and the output cannot be distinguished as to what crude input that started the flow. Here we have chosen to use the output fractions specified for the CRM flow. Note that there is a volume gain of 10% from the ADDS input, and a volume gain of 12% from the ADGO input. The destination of the output flows from the CC unit are as blending components for FG, PG, RG, DS, and FO, as shown in the Table 12.

	Output Fractions		
	CCFG	CCGA	CCGO
Input ADDS	0.30	0.59	0.21
Input ADGO	0.31	0.59	0.22

Table 11: Output fractions from the catalytic cracker.

For the input-output combinations of the catalytic cracking unit, the quality transformations are given in Table 13. While the original model trails the flows originating from each crude oil, in our model we define but one stream from the atmospheric distiller (for example only ADGO, and not ADGO from CRM and ADGO from CRW). Feeding the stream of ADGO into the catalytic cracker, we similarly get one CCFG, one CCGA, and one CCGO, all originating from ADGO. Thus, we have had to modify the data of the original example. In this we have applied the average change from the data given for the two crude oils: For the CCGO output originating from ADDS, we have an 1% density increase $((294.4/292+299.1/297.6)/2=1.01)$, and an 1% sulphur decrease $((0.353/0.526+1.31/2.83)/2=0.57)$. For

	Destination Products (Blending Components)				
	FG	PG	RG	DS	FO
Fuel gas fraction (CCFG)	x				
Gasoline fraction (CCGA)		x	x		
Gas oil fraction (CCGO)				x	x

Table 12: Possible destinations for the outputs from the catalytic cracker.

the CCGO output originating from ADGO, we an 1% density decrease $((294.4/295+299.1/303.3)/2=0.99)$, and a 69% sulphur decrease $((0.353/0.98+1.31/5.05)/2=0.31)$.

Input	Output	Density	Sulphur Content	Clear Research Octane	Vapour Pressure
ADDS	CCFG	-	-	-	-
ADDS	CCGA	-	-	new value 93.7	new value 6.9
ADDS	CCGO	+1%	-43%	-	-
ADGO	CCFG	-	-	-	-
ADGO	CCGA	-	-	new value 93.7	new value 6.9
ADGO	CCGO	-1%	69%	-	-

Table 13: Quality transformations in the catalytic cracker.

3.4.3 Hydrotreater (HT)

The sole input to the HT unit is ADRS. The processing capacity of the HT unit is not specified and is assumed not to be a constraint. The operating costs are 0.1 \$/bbl processed.

The output from the hydro treating unit is residuals (HTRS). Table 14 shows the fraction of output, implying a 3% volume loss. The destination of the output flows from the HT unit is as a blending component for fuel oil, as shown in Table 15.

	Output Fraction HTRS
Input ADRS	0.97

Table 14: Output fraction from the hydrotreater.

For the single input-output combination of the reforming unit, the quality transformations are given in Table 16. In the original example, only residuals originating from CRW may be treated in the HT unit. In our modified example, the ADRS outflow represents residuals from the mixed crudes. For the density transformation, we have from the original example $365/365=1$, that is no change. The sulphur content of the residual in the original example is reduced from 11 to 6, that is, however, for the residuals originating from the CRW only. We have therefore kept 6 as best obtainable sulphur content from HT.

	Destination Products (Blending Components)				
	FG	PG	RG	DS	FO
Residuals fraction (HTRS)					x

Table 15: Possible destinations for the outputs from the hydrotreater.

Input	Output	Density	Sulphur Content	Clear Research Octane	Vapour Pressure
ADRS	HTRS	no change	new value 6	-	-

Table 16: Quality transformations in the hydrotreater.

4 NETWORK SHEET

The refinery flowchart is defined in the *Network* sheet. This includes all nodes as e.g. inputs, products, processing units and all arcs (flows) connecting the nodes. In addition the names of the applied quality attributes are defined, as well as run options for solving the optimization. The *Network* sheet consists of 11 tables, organized as follows:

- **Network nodes and quality attributes:** Specification of network nodes and quality set in the 7 tables of *network_set_Oil_in*, *network_set_CDUs*, *network_set_processes*, *network_set_components*, *network_set_products*, *network_set_splits*, and *network_set_qualities*, see Section 4.1.
- **Network arcs:** Specification of network arcs in Table *network_set_arcs*, see Section 4.2.
- **Run options:** Specification of options for solving the optimization problem in tables *Parameters*, *AMPL_options*, and *Solver_options*, see Section 4.3.

The following sections give a detailed description of each table. In solving the optimization problem the ROP platform automatically generates a graphical representation of the network showing all nodes and arcs. This enables the user to check whether the input of the network is correct. Further, ROP also generates a graphical representation of the flows and qualities of the solution. See Chapters 9 and 10 for a guide to generating a graphical flow chart.

4.1 Tables of Network Nodes and Quality Attributes

The nodes (sets) in are defined in 7 different tables. The first 6 tables cover network nodes, i.e. input, CDUs, processing units, components, products and split nodes. The last table is for defining the set of quality attributes used in the refinery model. In each table all the nodes relevant to the category are listed vertically. The last step in finishing each table is to check that the excel-name of the table area is set to be the same as the table name.

4.1.1 Table *network_set_Oil_in*

The table *network_set_Oil_in* is a vertical list of all inputs to the refinery. This will normally be all crude oils, and in addition additives, components and other chemicals.

Note that consistency in names is required in all excel sheets. When writing the names of the input, the names have to be spelt identically as chosen in this table. Also note that the node names are case-sensitive, thus *Crude1* \neq *crude1*.

The table name *network_set_Oil_in* is a preset name in the program, and is also the excel-name of the area covered by this table. After having made changes in the table, make sure to redefine the area of this excel-name so that it coincides with the actual table area. Remember that the column-heading immediately above the table data, i.e. *Oil_in*, is to be included in the table area, and cannot be changed.

Case Example: Table 17 shows the *network_set_Oil_in* table of the case example. There are two crude oil inputs to the refinery (see Section 3.1). In addition the refinery purchases butane. The first row of the table has to be *Oil_in*, the next rows are the names of these elements, as seen in Table 17.

Oil_in
CRM
CRW
BU

Table 17: The table *network_set_Oil_in* in the *Network* sheet for the case example.

4.1.2 Table *network_set_CDUs*

The Table *network_set_CDUs* is a vertical list of all distillation units in the refinery.

Note that consistency in names is required in all excel sheets. When writing the CDU names elsewhere in the excel workbook, the names have to be spelt identically as chosen in this table. Also note that the node names are case-sensitive, thus *cdu* \neq *CDU*.

The table name *network_set_CDUs* is a preset name in the program, and is also the excel-name of the area covered by this table. After having made changes in the table, make sure that to redefine the area of this excel-name so that it coincides with the actual table area. Remember that the column-heading immediately above the table data, i.e. **CDUs**, is to be included in the table area, and cannot be changed.

Case Example: Table 18 shows the *network_set_CDUs* table of the case example. In Section 3.3 we find that there is one CDU, the atmospheric distiller AD. Thus, the set CDUs consists of only 1 element. The first row of the table has to be **CDUs**, the next row is the name of this element, see Table 18.

CDUs
AD

Table 18: The table *network_set_CDUs* in the *Network* sheet for the case example.

4.1.3 Table *network_set_processes*

The table *network_set_processes* is a list of all processing units in the refinery, except for the distillation units which are listed under the table above.

Note that consistency in names is required in all excel sheets. When writing the process names, the names have to be spelt identically as chosen in this table. Also note that the node names are case-sensitive, thus *Reformer* \neq *REFORMER*.

The table name *network_set_processes* is a preset name in the program, and is also the excel-name of the area covered by this table. After having made changes in the table, make sure that to redefine the area of this excel-name so that it coincides with the actual table area. Remember that the column-heading immediately above the table data, i.e. *Processes*, is to be included in the table area, and cannot be changed.

Case Example: Table 19 shows the *network_set_processes* table of the case example. In Section 3.4 we find that there are three processing units aside from the CDU. These are RF, CC, and HT. The first row of the table has to be *Processes*, the next rows are the names of these elements as seen in Table 19.

Processes
RF
CC
HT

Table 19: The table *network_set_processes* in the *Network* sheet for the case example.

4.1.4 Table *network_set_components*

Table *network_set_components* is a list of all components. Components are used for blending the final products. This may be either products from the CDUs or from the processes. Note that all products are blended from components. Even in the case where the direct and only use of an outflow from the CDU is a marketable final product, a component has to be defined which in this case is 'blended' on a 1:1 basis to the final product. The same applies to purchased additives. These have to first be redefined as a component before added in the blending process.

Note that consistency in names is required in all excel sheets. When writing the input names, the names have to be spelt identically as chosen in this table. Also note that the node names are case-sensitive, thus MTBE \neq mtbe.

The table name *network_set_components* is a preset name in the program, and is also the excel-name of the area covered by this table. After having made changes in the table, make sure to redefine the area of this excel-name so that it coincides with the actual table area. Remember that the column-heading immediately above the table data, i.e. *Components*, is to be included in the table area, and cannot be changed.

Tips in Defining Component Names: You are free to use the names of your choice for the component nodes, however, some notational conventions may help you keep a clear structure. To clearly state which nodes are components, you may for example denote all components with a prefix, for example CO. This is especially useful in cases where there are components that are blended in a 1:1 proportion to products, so that the component is distinguished from the final product.

Case Example: Table 20 shows the *network_set_components* table of the case example. In the example there are several outflows from the CDU and from processes that are used for the blending of the final products. There are 6 outflows directly from the AD that may be used as blending components (ADFG, ADGA, ADNA, ADDS, ADGO, and ADRS, cf. Table 3), 2 outflows from RF that may be blended to products (RFFG and RFGA, cf. Table 9), 3 different blending components from CC (CCFG, CCGA, and CCGO, cf. Table 12), and 1 blending component from HT (HTRS, cf. Table 15). In addition the purchased butane (BU), cf. Section 3.1 is used in blended products. As for the name the components, we have added the prefix X to the flow specification (e.g. for XADFG we have that X denotes that this is a component, AD denotes the originating unit, and FG the name of the flow). The first row of the table has to be *Components*, the next rows are the names of these elements.

Components
XADFG
XADGA
XRFFG
XRFGA
XRFNA
XADDS
XCCFG
XCCGA
XADGO
XCCGO
XADRS
XHTRS
XBU

Table 20: The table *network_set_components* in the *Network* sheet for the case example.

4.1.5 Table *network_set_products*

The Table *network_set_products* is a vertical list of all products from the refinery.

Note that consistency in names is required in all excel sheets. When writing the product names, the names have to be spelt identically as chosen in this table. Also note that the node names are case-sensitive, thus propane \neq Propane.

The table name *network_set_products* is a preset name in the program, and is also the excel-name of the area covered by this table. After having made changes in the table, make sure to redefine the area of this excel-name so that it coincides with the actual table area. Remember that the column-heading immediately above the table data, i.e. *Products*, is to be included in the table area, and cannot be changed.

Tips in Defining Product Names: You are free to use the names of your choice on the component nodes, however, some notational conventions may however help you keep a clear structure. To clearly state which nodes are products, you may for example denote all products with a prefix, for example PR.

Case Example: Table 21 shows the *network_set_products* of the case example. The refinery produces 5 products, including fuel gas which is used internally. These are FG, PG, RG, DS, and FO, cf. Section 3.2. The first row of the table has to be *Products*, the next rows are the names of these elements.

Products
FG
PG
RG
DS
FO

Table 21: The table *network_set_products* in the *Network* sheet for the case example.

4.1.6 Table *network_set_splits*

In some instances the flow from the CDU or a process may be directed towards several different categories of destinations, as for instance to another process *and* to a blending component. In this case a split-node has to be defined. All split nodes are to be listed in table *network_set_splits*.

Note that consistency in names is required in all excel sheets. When writing the split node names, the names have to be spelt identically as chosen in this table. Also note that the node names are case-sensitive, thus split1 \neq Split1.

The table name *network_set_splits* is a preset name in the program, and is also the excel-name of the area covered by this table. After having made changes in the table, make sure that to redefine the area of this excel-name so that it coincides with the actual table area. Remember that the column-heading immediately above the table data, i.e. **Splits**, is to be included in the table area, and cannot be changed.

Tips in Defining Node Names: You are free to use the names of your choice on the split nodes of the network. Some notational conventions may however help you keep a clear structure. To clearly see what nodes are split nodes when reading your network, you may give the split nodes a prefix, for example SN. Further, to recognize the flow they represent, you may want a name that indicates the flow which is split. For example, if the flow to be split is Kerosene straightly run from the CDU, the splitnode may be given the name SNCDUKerosene.

Case Example: Table 22 shows the *network_set_splits* of the case example. From the AD output destination Table 3, we see that ADFG and ADGA only are used as a blending component. In this case there is no need for a split node. However, the naphtha fraction ADNA is used as an input both to RF, *and* as a blending component. In this case, a split node is required. This is also the case for the flows of ADDS, ADGO, and ADRS. To denote the splitnodes, we have added the prefix N. The first row of the table has to be *Splits*, the next rows are the names of these elements.

Splits
NADNA
NADDS
NADGO
NADRS

Table 22: The table *network_set_splits* in the *Network* sheet for the case example.

4.1.7 Table *network_set_qualities*

Table *network_set_qualities* is a list of all relevant quality attributes. Note that the quality 'density' is required, and that the name has to be spelled exactly in this way, with lower cases.

Consistency in names is required in all excel sheets. When writing the quality names, the names have to be spelled identically as chosen in this table. Also note that the node names are case-sensitive, thus sulphur \neq Sulphur.

The table name *network_set_qualities* is a preset name in the program, and is also the excel-name of the area covered by this table. After having made changes in the table, make sure that to redefine the area of this excel-name so that it coincides with the actual table area. Remember that the column-heading immediately above the table data, i.e. *Qualities*, is to be included in the table area, and cannot be changed.

Case Example: Table 23 shows the *network_set_qualities* of the case example. Relevant qualities in the example are specified in Section 3.2, here named density, sulphur, octane and vapour. Note that density is a reserved quality, which has to be included, and spelled exactly as 'density' with lower cases. The first row of the table has to be *Qualities*, the next rows are the names of these elements.

Qualities
density
sulphur
octane
vapour

Table 23: The table *network_set_qualities* in the *Network* sheet for the case example.

4.2 Table *network_set_arcs*

The second part of the *Network* sheet defines the arcs of the network. Table *network_set_arcs* is a list of all arcs in the network where each arc is entered in a separate row with three columns:

Column From: Each arc has a starting node and an end node. In this column you specify the starting node of the arc. Be sure to specify the node name exactly as in tables of net-

work nodes. (The starting node may be any node in the tables of *network_set_Oil_in*, *network_set_CDUs*, *network_set_processes*, *network_set_components*, or *network_set_splits*.)

Column To: In this column you specify the ending node of the arc. Be sure to specify the node name exactly as in tables of network nodes. (The ending node may be any node in the tables of *network_set_CDUs*, *network_set_processes*, *network_set_components*, *network_set_splits*, or *network_set_products*.)

Column ArcName: In the last column the arc name is required specified for selected arc categories, and not allowed for the other arc categories: For arcs showing the destination of purchased inputs, and the destination of blending components, the arc name shall not be specified! For arcs showing the destination of CDU and process outputs, the arc name has to be specified. The arc names will later be used in the table of *CDU_exchange* in the *CDUDefinitions* sheet, and in table *Process_definition* in the *ProcessDefinitions* sheet.

The table name *network_set_arcs* is a preset name in the program, and is also the excel-name of the area covered by this table. After having made changes in the table, make sure to redefine the area of this excel-name so that it coincides with the actual table area. Remember that the column-headings immediately above the table data, i.e. *From*, *To*, and *ArcName* are to be included in the table area, and cannot be changed.

Tips in Organizing Arcs: The sequence of defining the arcs is at your choice. However, to be sure you cover all arcs, we propose a systematic approach:

1. **Arcs Showing the Destination of Components:** Specify the destination of all nodes listed in table *network_set_components*. These rows show which components are blended into which products. The *From* column contains the starting node, i.e. a node from the table *network_set_components*. If the component can be used in several products, specify a separate line for each destination. The *To* column contains the destination node. For all components, the destination is a product from the table *network_set_products*. Note that the *ArcName*-column must be left *blank* for all arcs specifying the destination of component nodes!
2. **Arcs Showing the Destination of Inputs:** Specify the destination of all nodes listed in table *network_set_Oil_in*. The *From* column contains the starting node, i.e. a node from this table. Each and every of these nodes has to be specified in a separate line. If the input has alternative destinations, one arc is specified for each destination. The *To* column contains the destination node. For all Crude-oils, the destination node will usually be a CDU from the table *network_set_CDUs*. For the other imports, the destination will be a process node from table *network_set_processes* or a component node from table *network_set_components*. The *ArcName*-column must be left *blank* for all arcs specifying the destination of nodes from table *network_set_Oil_in*.
3. **Arcs Showing the Destination of CDUs:** Specify the destination of the outputs from all CDUs in the table *network_set_CDUs*. An arc must be specified for each type of output from the CDU. The *From* column will be the node name of the CDU. The *To* column will be a process from table *network_set_processes*, a component from table *network_set_components* or a split-node from

table *network_set_splits*. Each type of output from the CDU can have only one destination. (If a given output from the CDU (e.g. Light-Naphtha) has two or more destinations, the destination in the *To*-column must be a split-node.) In the *ArcName* column the name of the arc is specified.

4. **Arcs Showing the Destination of Split-Nodes:** Specify the destination of all split-nodes in the table *network_set_splits*. The *From* column contains the starting node, here a node from this table. As there will be several destinations from the split-node, a new row with a separate arc for each outflow is required. The *To* column contains the destination node. The destination may be a process from table *network_set_processes* or a component node from table *network_set_components*. For all arcs specifying the destination of a split-node, the arc name must be specified in the *ArcName*-column.
5. **Arcs Showing the Destination of Processes:** Specify the destination of all processes in the the table *network_set_processes*. The *From* column contains the starting node, i.e. a node from this table. If there are several outflows from a process, a new row with a separate arc is specified for each outflow. The *To* column contains the destination node. The destination may be a component from table *network_set_components*, another process from table *network_set_processes*, or a split-node from table *network_set_splits*. For all arcs specifying the destination of a process, the arc name must be specified in the *ArcName* column.

Tips for Meaningful Arc Names: An unambiguous and informative naming of the arcs in column *ArcName* is given by combining the process node in the *From* column with the destination node in the *To* column. You may want to separate the names with an underscore. For example, for a flow from the process Cracker to the component XButane, the arc name may be Cracker_XButane.

Case Example: Table 24 shows the *network_set_arcs* table of the case example.

1. The first group of lines show the destination of all components. This information is found in tables 3, 9, 12, and 15, comprising all flows that have the destination of a blending component. In addition the purchased butane is used directly as a blending component. We have chosen the prefix 'X' to denote components. For components, the *ArcName* is *not* to be specified.
2. Next we have listed the destinations of all inputs, that is crude oils which are input to the AD (cf. Section 3.3), and imported BU which is directly used as a blending component, (cf. Section 3.1). For input destinations, the *ArcName* is *not* to be specified.
3. AD has six outflows, see table 3. The outflow of fuel gas (ADFG) and straight run gasoline (ADGA), are used directly and only as blending components. In the *From* column the originating node AD is entered, while the destination node which is a blending component is entered in the *To* column, as for example XADFG. Here the *ArcName* has to be specified in the *ArcName* column. We have named it by simply connecting the from- and to- node by an underscore _, e.g. AD_XADFG. The remaining outflows of ADNA, ADDS, ADGO, and ADRS have the two possible destinations of a component node or process node. Also for these, the originating node in the *From* column is AD. However, the destination in the *To* column has to be a split-node. For example for the outflow from the AD consisting of naphtha (ADNA), we have AD in the *From* column, NADNA in the *To* column, and the connected name AD_NADNA in the *ArcName* column.

4. Following up the split nodes, we find in table 3 that each of the four required split-nodes have two destinations, a process and as a blending component. Thus, two rows are entered for each split-node. For NADNA the two destinations are RF and XADNA, giving the first row with NADNA in the *From* column, RF in the *To* column, and NADNA_RF in the *ArcName* column. Similarly, the second row has NADNA in the *From* column, XADNA in the *To* column, and NADNA_XADNA in the *ArcName* column.
5. The destinations of the 3 processing units are given in tables 9, 12, and 15. A separate row is specified for each outflow of the processes. For example, RF has two outflows, to XRFFG and XRFGA, where the first row of these rows has RF in the *From* column, XRFFG in the *To* column, and RF_XRFFG in the *ArcName* column.

4.3 Tables of Run Options

The last tables of the *Network* sheet are tables concerning options in solving the optimization problem. The input is organized in the three tables of *Parameters*, *AMPL_options* and *Solver_options*. For further information on solving and running the problem see Section 9.

4.3.1 Table Parameters

The parameters for the case example are given in Table 25. If *Solve_non_linear_model* is set to 1, then the nonlinear problem is solved. Otherwise the start solution which come from solving one or a few linear approximations of the nonlinear model is used as the final solution. If *Show_warnings* is set to 1 then warning messages regarding possible errors in the data are printed. If set to 0 these warning messages are suppressed. The number of time periods the problem is to be solved for is specified in the parameter *NO_time_periods*. This makes it possible to solve the problem over only a subset of the time periods if needed. Postscript files of the network, volumes and the other qualities for the solution are saved if *Recreate_network* is given the value 1.

4.3.2 Table AMPL_options

An example of possible options for AMPL are given in Table 26. See [5] for an extensive list of AMPL options.

4.3.3 Table Solver_options

It is also possible to give options for the solver. These are given in the table *Solver_options*. In Table 27 we present the solver options we used to solve the case example. A more extensive list of solver options for the solver MINOS can be found in [7].

From	To	ArcName
XADFG	FG	
XADGA	PG	
XADGA	RG	
XRFFG	FG	
XRFGA	PG	
XRFGA	RG	
XADNA	PG	
XADNA	RG	
XADNA	DS	
XADDS	DS	
XCCFG	FG	
XCCGA	PG	
XCCGA	RG	
XADGO	DS	
XADGO	FO	
XCCGO	DS	
XCCGO	FO	
XADRS	FO	
XHTRS	FO	
XBU	PG	
XBU	RG	
CRM	AD	
CRW	AD	
BU	XBU	
AD	XADFG	AD_XADFG
AD	XADGA	AD_XADGA
AD	NADNA	AD_NADNA
NADNA	RF	NADNA_RF
NADNA	XADNA	NADNA_XADNA
AD	NADDS	AD_NADDS
NADDS	CC	NADDS_CC
NADDS	XADDS	NADDS_XADDS
AD	NADGO	AD_NADGO
NADGO	CC	NADGO_CC
NADGO	XADGO	NADGO_XADGO
AD	NADRS	AD_NADRS
NADRS	XADRS	NADRS_XADRS
NADRS	HT	NADRS_HT
RF	XRFRG	RF_XRFFG
RF	XRFGA	RF_XRFGA
CC	XCCFG	CC_XCCFG
CC	XCCGA	CC_XCCGA
CC	XCCGO	CC_XCCGO
HT	XHTRS	HT_XHTRS

Table 24: The table *network_set_arcs* in the *Network* sheet for the case example.

Parameters	Value
Solve_non_linear_model	1
Show_warnings	1
NO_time_periods	1
Recreate_network	1

Table 25: The table *Parameters* in the *Network* sheet for the case example.

AMPL_option	Value
omit_zero_cols	1
omit_zero_rows	1
presolve	10
bad_subscripts	2

Table 26: The table *AMPL_options* in the *Network* sheet for the case example.

Solver_option	Value
penalty_parameter	0.5
Linesearch_tolerance	0.1
Minor_damping_parameter	2
Hessian_dimension	50
Summary_frequency	100
Summary_level	1
Minor_iterations	40
Major_iterations	10000

Table 27: The table *Solver_options* in the *Network* sheet for the case example.

5 SUPPLYDEMAND SHEET

In the *SupplyDemand* sheet details of supply and demand are given. The *SupplyDemand* sheet has tables for:

- **Supply specifications:** The *Supply* table specifies the availability of inputs, their prices and qualities, see Section 5.1.
- **Demand table:** The *Demand* table specifies the minimum and maximum sale possibilities, as well as minimum and maximum qualities requirements, see Section 5.2.

5.1 Table Supply

Table *Supply* provides specifications for all purchased inputs specified in Table *network_set_Oil_in* of the *Network sheet*, with a separate row for each element for each time period of the model. The table consists of $5 + n$ columns, where n is the number of qualities specified in the *network_set_qualities* table of the *Network* sheet. Note that all names must be consistent with the spelling in these tables. The columns are:

Column Time_period: The model may cover several time periods. In this column we denote the time-period for which the following line refers to. For a one period model, the number 1 is entered, and there is only one row for each input. In case several time periods are used, several data tables needs to be given multiple times.

Column Oil_in: In this column we state the name of the input node, i.e. the crude oils and other imports. Remember to quote the exact node name as specified in the *network_set_Oil_in* table of the *Network* sheet.

Column Supply_max: Maximum available supply is quoted in this column. In this table the supply is measured in units of volume. If there are no constraints on maximum purchases, the user has to specify an arbitrarily high number.

Column Supply_min: Minimum available supply is quoted in this column. In this table the supply is measured in units of volume. If there are no constraints on minimum purchase obligations, the number entered is 0.

Column Price: The estimated price of the period is specified in this column. The price has to be quoted in terms of your chosen standard volume unit.

Columns Qualities: Now follows one column for each quality specified in the *network_set_qualities* table of the *Network* sheet. The names of the columns have to be consistent with the qualities specified in this table. If the quality attributes are not meaningful, or not available for the input in question, the number 0 has to be entered. Note that qualities also may be initialized later when defining the output of CDUs or Processes.

The table name *Supply* is a preset name in the underlying program, and is also the excel-name of the area covered by this table. After having made changes in the table, make sure to redefine the area of this excel-name so that it coincides with the actual table area. Remember that the column-headings immediately above the table data, i.e. *Time_period*, *Oil_in*, *Supply_max*, etc. are to be included in the table area. (Also note that the five first column headings cannot be changed, and that the n next headings have to be consistent with the *network_set_qualities* table.)

Case Example: Table 28 shows the *Supply* table of the case example. The table has 9 columns, as there are 4 quality attributes. The headings of these columns have to be *Time_period*, *Oil_in*, *Supply_max*, *Supply_min*, *Price*, *density*, *sulphur*, *octane*, and *vapour*. Note that the quality names are spelled exactly as in Table 23). We have one period in our model, thus each input is entered in only one row, with the number 1 in the *Time_period* column. There are two crude oil inputs, cf. Section 3.1. Maximum supply per day is 200,000 barrels, so 200 this is entered in *Supply_max* column, keeping numbers in 1,000 barrels. There is no minimum required purchase, thus the number 0 is entered in the *Supply_min* column. Prices are given in Section 3.1. As there are no quality specifications for the crude oil, we have entered the number 0 in the quality columns for the crude oil rows. (Necessary quality specifications are given later in specifying the outflows of the AD). Lastly, the imported input of BU is entered in a separate row. There are no limits on supply, so we have entered the arbitrarily large number 999999 in the *Supply_max* and 0 in the *Supply_min* column. The relevant qualities of octane and vapour are given in Section 3.1, for other qualities, the number 0 is entered.

Time_ period	Oil _in	Supply _max	Supply _min	Price	density	sulphur	octane	vapour
1	CRM	200	0	7.5	0	0	0	0
1	CRW	200	0	6.5	0	0	0	0
1	BU	999999	0	6.75	0	0	91.8	199.2

Table 28: The table *Supply* in the *SupplyDemand* sheet for the case example.

5.2 Table Demand

Table *Demand* provides specifications for all products specified in the Table *network_set_products* of the *Network* sheet, with a separate row for each product for each time period of the model. The table consists of $6 + 2n$ columns, where n is the number of qualities specified in the *network_set_qualities* table of the *Network* sheet. Note that all names must be consistent with the spelling in these tables. The columns are:

Column Time_period: The model may cover several time periods. In this column we denote the time-period for which the following line refers to.

Column Products: In this column we list the name of the product. Remember to quote the exact node name as specified in the *network_set_products* table of the *Network* sheet.

Column Demand_max: Maximum possible demand is quoted in this column. The maximum demand is here given in terms of volume. If there are no constraints as to maximum

purchases, the user has to specify an arbitrarily large number.

Column Demand_min: Minimum demand, for example due to contract obligations, is quoted in this column. The minimum demand is here given in terms of volume. If there are no constraints, the number 0 is entered.

Column Selling_price: There is a choice of specifying the product price in terms of price per volume unit or price per mass unit. If the choice is in terms of price per volume unit, the selling price of the product per volume unit is stated here. (If the user chooses to quote the price in terms of mass, the number 0 is entered here.)

Column Selling_price_mass: There is a choice of specifying the product price in terms of price per volume unit or price per mass unit. If the choice is in terms of price per mass unit, the selling price of the product per mass unit is stated here. (If the user chooses to quote the price in terms of volume, the number 0 is entered here.)

Columns Quality_min: There is one such column for each quality attribute. Any minimum restriction on quality is stated in this column. If there are no specifications, the number 0 has to be entered.

Columns Quality_max: There is one such column for each quality attribute. Any maximum restriction on quality is stated in this column. If there are no specifications, an arbitrarily large number has to be entered.

The table name *Demand* is a preset name in the underlying program, and is also the excel-name of the area covered by this table. After having made changes in the table, make sure to redefine the area of this excel-name so that it coincides with the actual table area. Remember that the column-headings immediately above the table data, i.e. *Time_period*, *Products*, *Demand_max*, etc. are to be included in the table area. (Also note that the five first column headings cannot be changed, and that the *n* next headings have to be consistent with the *network_set_qualities* table.)

Case Example: Table 29 shows the *Demand* table for the case example. The table has 14 columns, as there are 4 quality attributes. The headings of these columns have to be *Time_period*, *Products*, *Demand_max*, *Demand_min*, *Selling_price*, *Selling_price_mass*, *density_min*, *density_max*, *sulphur_min*, *sulphur_max*, *octane_min*, *octane_max*, *vapour_min*, and *vapour_max*. Note that the quality names are spelled exactly as in Table 23. We have one period in our model, thus each input is entered in only one row, with the number 1 in the *Time_period* column. There are five products, cf. Section 3.2, and where Table 1 gives all relevant information for the four marketable products. There are no restrictions or requirements as to demand, thus an arbitrarily large number is entered in the column, and 0 in the *Demand_min* column. In our case the price is given per volume (barrels), and thus entered in the *Selling_price* column, while the number 0 is entered in the *Selling_price_mass* column. Relevant quality maximum or minimum quality restrictions are entered for each quality. For entries where there are no specifications, a 0 is entered in the min-columns, and arbitrarily large numbers, here 999999, in the max-columns.

Time_ period	Products	Demand _max	Demand _min	Selling _price	Selling		density _min	density _max	sulphur _min	sulphur _max	octane _min	octane _max	vapour _min	vapour _max
					_price	_mass								
1	FG	999999	0	1.5	0	0	999999	0	999999	0	999999	0	999999	
1	PG	999999	30	10.5	0	0	999999	0	999999	90	999999	0	12.7	
1	RG	999999	0	9.1	0	0	999999	0	999999	86	999999	0	12.7	
1	DS	999999	0	7.7	0	0	306	0	0.5	0	999999	0	999999	
1	FO	999999	30	6.65	0	0	352	0	3.5	0	999999	0	999999	

Table 29: The table *Demand* in the *SupplyDemand* sheet for the case example.

6 INITIAL VALUES SHEET

In the *Initial Values* sheet the details of storage for crude oil, other imported items, and components are given. The *Initial Values* sheet has tables for:

- *Crude oil and imports storage*: The *Initial_supply* table specifies the volume, value and qualities of the storage at the starting point of the model. In addition storage costs and the value of any storage at the end of the optimization period are set. See Section 6.1.
- *Components storage*: The *Initial_component* table specifies the volume, value and qualities of the storage of components at the start of the model. In addition storage costs and and the value of storage at the end of the optimization period are set. See Section 6.2.

6.1 Table *Initial_supply*

Table *Initial_supply* provides details of storage for all purchased inputs specified in table *network_set_Oil_in* of the *Network* sheet, with a separate row for each of these elements. The table consists of $5 + n$ columns, where n is the number of qualities specified in the *network_set_qualities* table of the *Network* sheet. The columns are:

Column *Oil_in*: In this column we state the name of the input node, i.e. the crude oils and other imports. Remember to quote the exact node-name as specified in the *network_set_Oil_in* table of the *Network* sheet.

Column *Volume*: The volume of the initial storage is quoted in this column, and is set to 0 if there is no initial storage.

Column *Value_init*: The value per unit of the initial storage is quoted in this column, and is set to 0 if there is no initial storage.

Column *Value_end*: Here the value per unit of storage at the end of the optimization period is quoted, and is set to 0 if the model is of one period.

Column *Storage_cost*: In this column the cost of storage per volume unit for one time period is quoted, and is set to 0 if the model covers only one period.

Columns *Qualities*: Now follows one column for each quality specified in the *network_set_qualities* of the *Network* sheet. The number and names of columns has to be consistent with the quality set specified in in this table. In each column you specify the quality associated with the storage input. If there is no storage, or if the quality attributes are not meaningful or not available, the number 0 has to be entered.

The table name *Initial_supply* is a preset name in the underlying program, and is also the excel-name of the area covered by this table. After having made changes in the table, make sure to redefine the area of this excel-name so that it coincides with the actual table area. Remember that the column-headings immediately above the table data, i.e. *Oil_in*, *Volume*, *Value_init*, etc. are to be included in the table area. (Also note that the five first column headings cannot be changed, and that the n next headings have to be consistent with the *network_set_qualities* table.)

Case Example: Table 30 shows the *Initial_supply* table of the case example. Even though the case example does not have an initial supply of crude oil or butane, the table has to be completed, with one row for each element of the *network_set_Oil_in*, and with the appropriate number of columns, here 9 since we have four quality attributes. The heading of each column in our case are required to be: *Oil_in*, *Volume*, *Value_init*, *Value_end*, *Storage_cost*, *density*, *sulphur*, *octane*, and *vapour*. Since there is no initial supply, the table data are entered as 0.

Oil_in	Volume	Value_init	Value_end	Storage_cost	density	sulphur	octane	vapour
CRM	0	0	0	0	0	0	0	0
CRW	0	0	0	0	0	0	0	0
BU	0	0	0	0	0	0	0	0

Table 30: The table *Initial_supply* in the *Initial Values* sheet for the case examples.

6.2 Table Initial_component

Table *Initial_component* provides details of component storage for all components specified in table *network_set_components* of the *Network* sheet, with a separate row for each of these elements. The table consists of $5 + n$ columns, where n is the number of qualities specified in the *network_set_qualities* table of the *Network* sheet. The columns are:

Column Component: In this column we put the name of the component. Remember to quote the exact node-name as specified in the *network_set_components* table of the *Network* sheet.

Column Volume: The volume of the initial storage of the component is quoted in this column, and is set to 0 if there is no initial storage.

Column Value_init: The value per unit of the initial storage of the component is quoted in this column, and is set to 0 if there is no initial storage.

Column Value_end: Here the value per unit of the storage at the end of the optimization period is quoted, and is set to 0 if it is a one-period model.

Column Storage_cost: In this column the cost of storage per volume unit for one time period is quoted, and is set to 0 if the model covers only one period.

Columns Qualities: Now follows one column for each quality specified in the *network_set_qualities* of the *Network* sheet. The number and names of columns has to be consistent with the quality set specified in in this table. In each column you specify the quality associated with the storage input. If there is no storage, or if the quality attributes are not meaningful or not available, the number 0 has to be entered.

The table name *Initial_component* is a preset name in the underlying program, and is also the excel-name of the area covered by this table. After having made changes in the table, make sure to redefine the area of this excel-name so that it coincides with the actual table area. Remember that the column-headings immediately above the table data, i.e. *Component*, *Volume*, *Value_init*, etc. are to be included in the table area. (Also note that the five first column headings cannot be changed, and that the *n* next headings have to be consistent with the *network_set_qualities* table.)

Case Example Table 31 shows the *Initial_component* table of the case example. Even though the case example does not have an initial supply of components, the table has to be completed, with one row for each component, here 13, and with the appropriate number of columns, here 9 since we have four quality attributes. The column headings in our case are required to be: *Component*, *Value_init*, *Value_end*, *Storage_cost*, *density*, *sulphur*, *octane*, and *vapour*. Since there is no initial storage of components, the table data are entered as 0.

Component	Volume	Value _init	Value _end	Storage _cost	density	sulphur	octane	vapour
XADFG	0	0	0	0	0	0	0	0
XADGA	0	0	0	0	0	0	0	0
XRFFG	0	0	0	0	0	0	0	0
XRFGA	0	0	0	0	0	0	0	0
XADNA	0	0	0	0	0	0	0	0
XADDS	0	0	0	0	0	0	0	0
XCCFG	0	0	0	0	0	0	0	0
XCCGA	0	0	0	0	0	0	0	0
XADGO	0	0	0	0	0	0	0	0
XCCGO	0	0	0	0	0	0	0	0
XADRS	0	0	0	0	0	0	0	0
XHTRS	0	0	0	0	0	0	0	0
XBU	0	0	0	0	0	0	0	0

Table 31: The table *Initial_component* in the *Initial Values* sheet for the case example.

7 CDUDEFINITIONS SHEET

In the *CDUDefinitions* sheet details of the transformation within the CDUs are given, as well as the costs and capacity constraints. The *CDUDefinitions* sheet has tables for:

- **CDU transformation:** The *CDU_Exchange* table specifies the connection between input and output of the CDU with respect to volumes and qualities of the output, see Section 7.1.
- **CDU capacities and costs:** The *CDU_capacities* table specifies capacities, and variable operating costs of the CDU for each time period, see Section 7.2.

7.1 Table *CDU_Exchange*

Table *CDU_Exchange* provides specifications on the connection between between CDU input and output. For a given CDU, there is for each crude oil input to the CDU entered as many rows as the number of possible outflows from the CDU. For example, for 2 CDUs, 3 crude oils and 10 CDU-outflows, there will be $2 * 3 * 10 = 60$ rows in the table. The table has $4 + n$ columns, where n is the number of qualities specified in the *network_set_qualities* table of the *Network* sheet. The columns are:

Column CDU: Here the name of the CDU is specified. Remember to quote the exact node-name as specified in the *network_set_CDUs* table of the *Network* sheet.

Column CDU_in: Here the name of the crude oil input is specified. Remember to quote the exact node-name as specified in the *network_set_Oil_in* table of the *Network* sheet. Note that only crude oils are inputs, and not the other imports).

Column CDU_out: In this column the name of the *arc* of each outflow is specified. The arc names are found in *ArcName* column of the *network_set_arcs* table in the *Network* sheet. (These are arcs where a CDU-name is specified in the *From* column).

Column Fraction: The CDU splits the crude oil into several outflows. In this column you specify the fraction of crude oil volume which is transformed into each category of CDU-outflow. *The sum of all fractions for a given crude oil input has to amount to 1.000.*

Columns Qualities: For each quality attribute, the quality level of each outflow is specified.

The table name *CDU_exchange* is a preset name in the underlying program, and is also the excel-name of the area covered by this table. After having made changes in the table, make sure to redefine the area of this excel-name so that it coincides with the actual table area. Remember that the column-headings immediately above the table data, i.e. *CDU*, *CDU_in*, *CDU_out*, etc. are to be included in the table area. (Also note that the four first column headings cannot be changed, and that the n next headings have to be consistent with the *network_set_qualities* table.)

Tips in Organizing the CDU_exchange Table: The sequence of rows is at your choice. However, to be sure you cover all combinations, we propose a systematic approach. First we recommend that you finish all the rows for one CDU at a time. With n crude oils and m outflows from the CDU, you specify $n * m$ rows for that CDU. Secondly, when dealing with the individual CDU, we recommend that you finish all rows for each crude oil first. With m outflows from each CDU, you specify m rows for each crude oil input. The m rows comprise all arcs listed in the *network_set_arcs* table of the *Network* sheet where the named CDU is quoted in the *From* column.

Case Example: Table 32 shows *CDU_exchange* table of the case example. In the example we have one CDU, the AD unit. There are two inputs, CRM and CRW, and 6 outputs. To cover all combinations, we have to enter $1 \times 2 \times 6 = 12$ rows. There are 8 columns as we have 4 quality attributes. In the *CDU_out* column the relevant arc names are specified, cf. the arc Table 24. Output fractions are given in Table 2. Quality specifications are found in tables 4- 7. For non-relevant or not specified qualities, a 0 is entered.

CDU	CDU_in	CDU_out	Fraction	density	sulphur	octane	vapour
AD	CRM	AD_XADFG	0.029	0	0	0	0
AD	CRM	AD_XADGA	0.236	0	0	78.5	18.4
AD	CRM	AD_NADNA	0.223	272.0	0.283	65.0	6.54
AD	CRM	AD_NADDS	0.087	292.0	0.526	0	0
AD	CRM	AD_NADGO	0.111	295.0	0.980	0	0
AD	CRM	AD_NADRS	0.314	343.0	4.700	0	0
AD	CRW	AD_XADFG	0.017	0	0	0	0
AD	CRW	AD_XADGA	0.180	0	0	78.5	18.4
AD	CRW	AD_NADNA	0.196	272.0	1.480	65	6.54
AD	CRW	AD_NADDS	0.073	297.6	2.830	0	0
AD	CRW	AD_NADGO	0.091	303.3	5.050	0	0
AD	CRW	AD_NADRS	0.443	365.0	11.00	0	0

Table 32: The table *CDU_Exchange* in the *CDUDefinitions* sheet for the case example.

7.2 Table CDU_capacities

Table *CDU_capacities* provides specifications on capacities and variable processing costs of the CDUs. A separate row is entered for each CDU for each time period. The table consists of 5 columns. The columns are:

Column Time_period: In this column you specify the time period for which the costs and capacities apply to.

Column CDU: Here the name of the CDU is specified. Remember to quote the exact node-name as specified in the *network_set_CDUs* table of the *Network* sheet.

Column Cost: The cost to be quoted is the cost per volume unit of crude oil inflow to the CDU.

Column Lower: Here any lower capacity constraints as to the minimum possible through-flow in period is quoted. If there are no restrictions, the number 0 is entered.

Column Upper: The upper capacity constraint to maximum possible through-flow in the period is quoted here. If there are no restrictions, an arbitrarily large number is quoted.

The table name *CDU_capacities* is a preset name in the underlying program, and is also the excel-name of the area covered by this table. After having made changes in the table, make sure to redefine the area of this excel-name so that it coincides with the actual table area. Remember that the column-headings immediately above the table data, i.e. *Time_period*, *CDU*, *Cost*, etc. are to be included in the table area. (Also note that the column headings cannot be changed).

Case Example: Table 33 has the entries for the *CDU_capacities* table of the case example. The cost and limits of the AD unit are given in Section 3.3. We have specified quantities per 1,000 barrels, i.e. an upper capacity of 100,000 is denoted 100.

Time_period	CDU	Cost	Lower	Upper
1	AD	0.1	0	100

Table 33: The table *CDU_capacities* in the *CDUDefinitions* sheet for the case example.

8 PROCESS_DEFINITIONS SHEET

In the *Process_Definitions* sheet details of the transformation within the processing units are given, as well as the costs and capacity constraints of the processes. The *Process_Definitions* sheet has tables for:

- **Process transformation:** The *Process_definition* table specifies all input-output connections for the processes in terms of quality and volume, see Section 8.1.
- **Process capacities and costs:** The *Process_properties* table specifies capacities, and variable operating costs of the processing units for each time period, see Section 8.2.

8.1 Table Process_definition

Table *Process_definition* provides specifications on the connection between the input and output of processes, modelling the transformation taking place within the processes as to quantity and quality. All combinations of input and output flows have to be represented. For a process with m input flows and n output flows, there must be specified $m * n$ connections for this process. The transformation process is described by a polynomial up to the power of 2. To specify the three coefficients of the polynomial, there are three rows for each input-output combination, enabling the specification of coefficients to the power of 0, 1, and 2. The table consists of $5 + n$ columns, where n is the number of qualities specified in the quality set table. The columns are:

Column Process: In this column the name of the process is specified. The name must be spelled exactly as specified in the *network_set_processes* table of the *Network* sheet.

Column Process_in: This column states the inflow arc to the process. The *network_set_arcs* table of the *Network* sheet supplies the information of possible inflows. For a given process, all possible inflows are found by scanning the **To** column of the table for the process in question. It is the corresponding arc name of the **ArcName** column that is to be specified here. (In the special case where the inflow to the process is an imported product specified from the *network_set_Oil_in*, you specify the node-name of the imported product as no arc name is given in the *network_set_arcs* table.)

Column Process_out: In this column the name of the arc of the outflow of the process is specified. The *network_set_arcs* table supplies all information of possible outflows. For a given process, all possible outflows are found by scanning the *From* column of the table for the process in question. It is the name in the corresponding *ArcName* column that is to be specified here.

Column Power: The column power states the power of the volume and quality coefficients on the row. For each inflow-outflow combination, the three rows are given the numbers of 0, 1, and 2.

Column volume_coeff: Here the volume coefficient for the given power of the row is specified.

Column Quality_coeff: Here the quality coefficient for the given power of the row is specified.

Tips on Organizing the Process_definition Table: You may freely choose the sequence of rows. Remember that *all* combinations of inflows and outflows have to be stated for *all* processes. Also, all these combinations must be covered by the three rows for power 0, 1, and 2. To be sure to cover all combinations, you may follow the following recipe:

1. Give a full treatment of each process, before proceeding to any rows of other processes.
2. Give a full treatment of all possible inflow to the process, before proceeding to any other inflows to the process.
3. For each inflow then cover all outflows from the process. Note that this list of outflows will be the same for all the inflows to the process. After this is done, proceed to the next inflow.

The table name *Process_definition* is a preset name in the underlying program, and is also the excel-name of the area covered by this table. After having made changes in the table, make sure to redefine the area of this excel-name so that it coincides with the actual table area. Remember that the column-headings immediately above the table data, i.e. *Process*, *Process_in*, *Process_out*, etc., are to be included in the table area. (Also note that the four first column headings cannot be changed, and that the prefix of the *n* next headings has to be consistent with the *network_set_qualities* table.)

Case Example: Table 34 shows the *Process_definition* table. There are 9 columns since we have 4 quality attributes. For each input-output combination there are 3 rows, to represent the transformations of power 0, 1, and 2. Below is an explanation of the table for our 3 processing units.

- For the RF unit there is 1 input and 2 outputs, cf. Table 8, resulting in $1 * 2 * 3 = 6$ rows. The arc names of inflow and outflow are specified in columns *Process_in* and *Process_out*, see Table 24. For example, NADNA_RF is the arc name for the flow from the split node NADNA to the reformer RF, and RF_XRFFG is the arc name for the flow from the reformer to the component fuel gas. The specified linear multiplicative output fractions are entered in the *volume_coeff* column, in the specified in power 1 row. The quality transformations are found in Table 10, specified for octane and vapour for the RF_XRFGA outflow. A 60% increase is represented by the linear multiplicative factor of 1.6 (power 1 row), a 60.7% decrease is represented by the linear multiplicative factor of 0.393. Here, the entries in the power 0 and power 2 row are set to 0. For the RF_XRFFG outflow (all qualities) and the RF_XRFGA outflow (density and sulphur), transformations are not specified. These are not relevant for the solving of the problem. However, the model requires entries, where we have (arbitrarily) specified a no change set of parameters, i.e. 0, 1, 0 in the power 0, 1, and 2 column respectively.

- For the CC unit, there are 2 inputs and 3 outputs, cf. Table 11, resulting in $2 \times 3 \times 3 = 18$ rows. This table also shows linear multiplicative output fractions. Quality transformations are found in Table 13. Note that the formulation 'New value 93.7' implies that the value is set to be 93.7 regardless of the quality of the inflow, thus 93.7 is entered in the power 0 row.
- For the HT unit, there is 1 input and 1 output, cf. Table 14, giving $1 \times 1 \times 3 = 3$ rows. This table also shows linear multiplicative output fractions. Quality transformations are found in Table 16. The formulation 'no change' implies a multiplicative linear factor of 1 entered in power row 1.

Process	Process_in	Process_out	Power	volume_coeff	density_coeff	sulphur_coeff	octane_coeff	vapour_coeff
RF	NADNA_RF	RF_XRFFG	0	0	0	0	0	0
RF	NADNA_RF	RF_XRFFG	1	0.129	1	1	1	1
RF	NADNA_RF	RF_XRFFG	2	0	0	0	0	0
RF	NADNA_RF	RF_XRFGA	0	0	0	0	0	0
RF	NADNA_RF	RF_XRFGA	1	0.807	1	1	1.6	0.393
RF	NADNA_RF	RF_XRFGA	2	0	0	0	0	0
CC	NADDS_CC	CC_XCCFG	0	0	0	0	0	0
CC	NADDS_CC	CC_XCCFG	1	0.300	1	1	1	1
CC	NADDS_CC	CC_XCCFG	2	0	0	0	0	0
CC	NADDS_CC	CC_XCCGA	0	0	0	0	93.7	6.9
CC	NADDS_CC	CC_XCCGA	1	0.590	1	1	0	0
CC	NADDS_CC	CC_XCCGA	2	0	0	0	0	0
CC	NADDS_CC	CC_XCCGO	0	0	0	0	0	0
CC	NADDS_CC	CC_XCCGO	1	0.210	1.01	0.57	1	1
CC	NADDS_CC	CC_XCCGO	2	0	0	0	0	0
CC	NADGO_CC	CC_XCCFG	0	0	0	0	0	0
CC	NADGO_CC	CC_XCCFG	1	0.310	1	1	1	1
CC	NADGO_CC	CC_XCCFG	2	0	0	0	0	0
CC	NADGO_CC	CC_XCCGA	0	0	0	0	93.7	6.9
CC	NADGO_CC	CC_XCCGA	1	0.590	1	1	0	0
CC	NADGO_CC	CC_XCCGA	2	0	0	0	0	0
CC	NADGO_CC	CC_XCCGO	0	0	0	0	0	0
CC	NADGO_CC	CC_XCCGO	1	0.220	0.99	0.31	1	1
CC	NADGO_CC	CC_XCCGO	2	0	0	0	0	0
HT	NADRS_HT	HT_XHTRS	0	0	0	0	0	0
HT	NADRS_HT	HT_XHTRS	1	0.970	1	0.45	1	1
HT	NADRS_HT	HT_XHTRS	2	0	0	0	0	0

Table 34: The table *Process_definition* in the *Process_definition* sheet for the case example.

8.2 Table Process_properties

Table *Process_properties* provides specifications on capacities and variable processing costs of the processing units. The user may choose to specify the capacity in terms of volume or mass. A separate row is entered for each processing unit for each time period. The columns are:

Column Time_period: In this column the time period for which the constraints and costs the row refers to is specified.

Column Process: Here the name of the processing unit is specified, as found in the *network_set_processes* table of the *Network* sheet.

Column In_lower: This is the *lower* constraint of *inflow* to the process, given that the constraint is expressed in terms of *volume* units. If there is no constraint, or if the constraint is entered in terms of mass, the number 0 is specified here.

Column In_upper: This is *upper* constraint of *inflow* to the process, given that the constraint is expressed in terms of *volume* units. If there is no constraint, or if the constraint is entered in terms of mass, the number 0 is specified here.

Column Out_lower: This is *lower* constraint of *outflow* from the process, given that the constraint is expressed in terms of *volume* units. If there is no constraint, or if the constraint is entered in terms of mass, the number 0 is specified here.

Column Out_upper: This is *upper* constraint of *outflow* from the process, given that the constraint is expressed in terms of *volume* units. If there is no constraint, or if the constraint is entered in terms of mass, the number 0 is specified here.

Column In_lower_mass: This is *lower* constraint of *inflow* to the process, given that the constraint is expressed in terms of *mass* units. If there is no constraint, or if the constraint is entered in terms of volume, the number 0 is specified here.

Column In_upper_mass: This is *upper* constraint of *inflow* to the process, given that the constraint is expressed in terms of *mass* units. If there is no constraint, or if the constraint is entered in terms of volume, the number 0 is specified here.

Column Out_lower_mass: This is *lower* constraint of *outflow* from the process, given that the constraint is expressed in terms of *mass* units. If there is no constraint, or if the constraint is entered in terms of volume, the number 0 is specified here.

Column Out_upper_mass: This is *upper* constraint of *outflow* from the process, given that the constraint is expressed in terms of *mass* units. If there is no constraint, or if the constraint is entered in terms of volume, the number 0 is specified here.

Column Cost: This is the cost per unit inflow to the process, where the inflow is measured in volume units. It is set to 0 if the inflow is measured in mass units.

Column Cost_mass: This is the cost per unit inflow to the process, where the inflow is measured in mass units. It is set to 0 if the inflow is measured in volume units.

The table name *Process_properties* is a preset name in the underlying program, and is also the excel-name of the area covered by this table. After having made changes in the table, make sure to redefine the area of this excel-name so that it coincides with the actual table area. Remember that the column-headings immediately above the table data, i.e. *Time_period*, *Process*, *In_lower*, etc. are to be included in the table area. (Also note that the column headings cannot be changed).

Case Example: Table 35 shows the entries of the *Process_properties* table. We have three processes, and one period. In our case limits are specified in volume, thus the limits are entered in the columns without the ending *_mass*. Lower limits for non-specified capacities are set to 0, and non-specified upper limits to the arbitrarily high number of 99999. As we have specified limits in terms of volume, the lower and upper limits in terms of mass are set to be unlimited with 0 and 99999.

Time_ period	Process	In_ lower	In_ upper	Out_ lower	Out_ upper	In_ lower _mass	In_ upper _mass	Out_ lower _mass	Out_ upper _mass	Cost	Cost_ _mass
1	RF	0	20	0	99999	0	99999	0	99999	0.15	0
1	HT	0	99999	0	99999	0	99999	0	99999	0.1	0
1	CC	0	30	0	99999	0	99999	0	99999	0.08	0

Table 35: The table *Process_properties* in the *Process_definition* sheet for the case example.

9 SOLVING THE OPTIMIZATION PROBLEM

Overview of the Optimization Problem: Underlying Mathematical Formulation The refinery planning problem is a nonlinear optimization problem. The optimization model used in the platform is general and is described in the separate report [2]. Here the objective function and all decision variables and constraints are defined and described.

Main Characteristics of the Optimization Problem and Solving Challenges The model includes many equality constraints with nonlinear constraint functions. The functions used are quadratic polynomials. Some are used to describe the processes and others are used to describe and compute the different quality characteristics such as density and sulphur. These aspects put together gives a non-convex and highly nonlinear formulation. The problem is in general very hard to solve even for smaller instances.

Recipe for Solving Procedure of the Optimization Problem In order to solve the problem it is important to use well defined functions. We have used quadratic approximations as they have shown to be useful and easy to use in other projects. One example is to describe the nonlinear bleaching process at a paper mill. This application is described in the article [4].

Another important aspect for solving nonlinear problems is to use a good starting point. Most solvers can be initialized in any starting point, but often show a bad performance if none are selected. This is true in particular for highly nonlinear problems. In our case we apply a two phase solution approach. In the first phase we solve some approximations of the original problem in order to establish a feasible flow through the refinery. The main idea is to find a good starting point. This flow can then be used to compute a set of values for the characteristics. Given the characteristic values we often have a very good starting point. The overall solution approach and some experiences are further described in [2].

Fixing and limiting variable values In the *Variables_read* sheet it is possible to limit the values of variables. The exact name of the variable (with possible indexes) is given as well as a value for the variable. Lower and upper bounds are given within which the variables are limited. It is also possible to fix the variable value at a given value. This is done by setting the value of the column *Is_fixed* to be 1. Otherwise it has to be 0. See Table 36 for an example.

Name	Value	Lower_bound	Upper_bound	Is_fixed
oil_buy['CRM',1]	70	0	200	0
oil_buy['CRW',1]	0	0	200	0
oil_buy['BU',1]	0.373	0	999999	0
oil_storage['CRM',1]	0	0	99999999	0
oil_storage['CRW',1]	0	0	99999999	0
oil_storage['BU',1]	0	0	99999999	0
oil_usage_CDU['AD','CRM',1]	89.72	0	99999999	0
oil_usage_CDU['AD','CRW',1]	0	0	99999999	0

Table 36: The table *Variables_read* in the *Variable_read* sheet for the case example.

10 OUTPUT AND REPORT GENERATION

The ROP platform reports the solution by the way of excel reports and graphical solutions:

Excel Reports The solution is also written back to the Excel sheet in a number of tables. This are further exemplified for our case example below.

Graphic Reports The ROP platform generates a unique graphical display of the solution, where flows and characteristics are display directly in the flow diagram of the refinery. The reports are generated as postscript files and can also be used as a basis for other reports.

Case Example Reports The ROP platform first generates a general overview of the refinery complex with all units, inputs, products and flows. The refinery network of our example is shown in Figure 3.

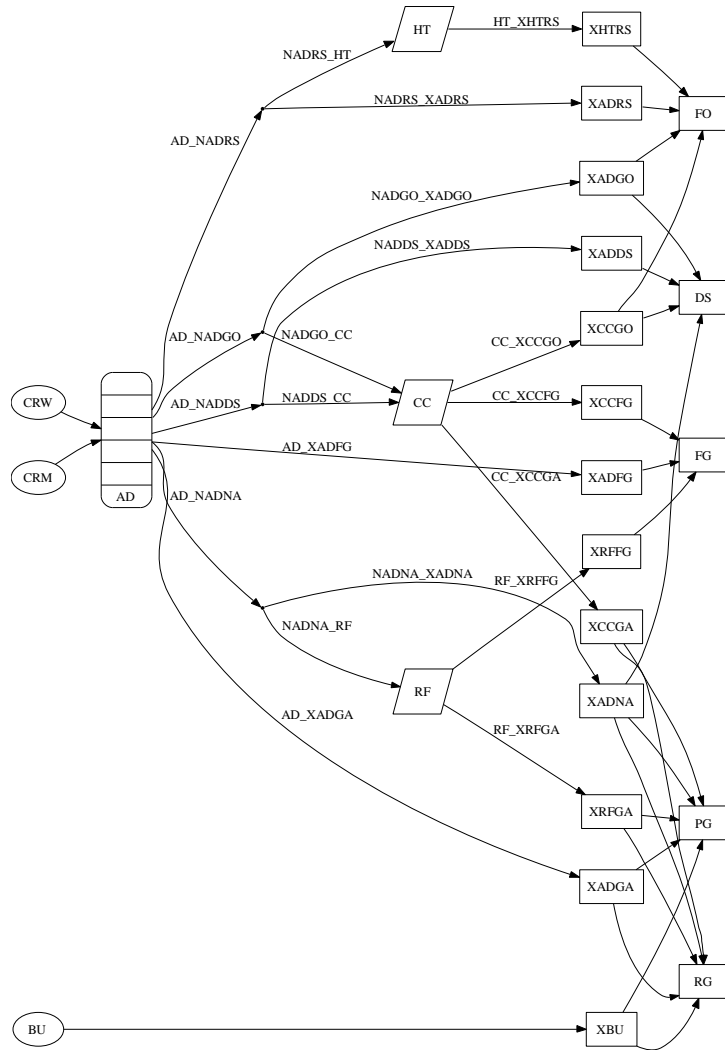

Figure 3: A refinery flow Chart of the case example.

A number of tables are generated in the excel document with data and sensitivity analysis of the solution. Table 37 gives data for the products, Table 38 gives data for the crude oils, Table 39 gives data for the production in the CDU, Table 40 gives data for all the outputs in the processes, Table 41 gives information for stored components and Table 42 gives information of the blending.

Product	Time_ period	Volume	Volume _dual	density	density _rc	sulphur	sulphur _rc	octane	octane _rc	vapour	vapour _rc
FG	1	10.4	1.5	225.1	0.0	1.4	0.0	16.0	0.0	1.6	0.0
PG	1	49.2	5.9	159.1	0.0	0.8	0.0	90.0	0.1	12.7	0.0
RG	1	0.0	0.0	0.0	0.0	0.0	0.4	86.0	0.1	0.0	0.0
DS	1	0.0	7.7	0.0	0.0	0.0	0.0	0.0	0.0	0.0	0.0
FO	1	40.6	8.9	350.2	0.0	3.5	-0.7	0.0	0.0	0.0	0.0

Table 37: Produced volumes of the different products in the solution to the case example.

Oil	Time_ period	Volume	Storage	density	sulfur	octane	vapor
CRM	1	49.9	0.0	0.0	0.0	0.0	0.0
CRW	1	50.1	0.0	0.0	0.0	0.0	0.0
BU	1	0.6	0.0	0.0	0.0	91.8	199.2

Table 38: Data for the utilized oils in the solution to the case example.

CDU	CDU _out	Time_ period	Volume	Volume _dual	density	density _dual	sulphur	sulphur _dual	octane	octane _dual	vapour	vapour _dual
AD	AD_XADFG	1	2.3	0.7	0.0	0.0	0.0	0.0	0.0	0.0	0.0	0.0
AD	AD_XADGA	1	20.8	4.8	0.0	0.0	0.0	0.0	78.5	0.1	18.4	0.0
AD	AD_NADNA	1	20.9	4.1	272.0	0.0	0.8	0.0	65.0	0.1	6.5	0.0
AD	AD_NADDS	1	8.0	7.8	294.6	0.0	1.6	-0.1	0.0	0.0	0.0	0.0
AD	AD_NADGO	1	10.1	7.9	298.7	0.0	2.8	0.0	0.0	0.0	0.0	0.0
AD	AD_NADRS	1	37.9	7.8	355.9	0.0	8.4	-0.3	0.0	0.0	0.0	0.0

Table 39: Data for the outputs from the CDU for the solution to the case example.

Process	Process_out	Time_period	Volume	Volume_dual	density	density_dual	sulphur	sulphur_dual	octane	octane_dual	vapour	vapour_dual
RF	RF_XRFFG	1	2.6	0.0	272.0	0.0	0.8	0.0	65.0	0.0	6.5	0.0
RF	RF_XRFGA	1	16.1	0.0	272.0	0.0	0.8	0.0	104.0	0.0	2.6	0.0
CC	CC_XCCFG	1	5.5	0.0	296.9	0.0	2.3	0.0	0.0	0.0	0.0	0.0
CC	CC_XCCGA	1	10.7	0.0	296.9	0.0	2.3	0.0	93.7	0.0	6.9	0.0
CC	CC_XCCGO	1	3.9	0.0	296.5	0.0	0.9	0.0	0.0	0.0	0.0	0.0
HT	HT_XHTRS	1	36.7	0.0	355.9	0.0	3.8	0.0	0.0	0.0	0.0	0.0

Table 40: Data for the output from the processes for the solution to the case example.

Component	Time_period	Volume	density	sulphur	octane	vapour
XADFG	1	0.0	0.0	0.0	0.0	0.0
XADGA	1	0.0	0.0	0.0	78.5	18.4
XRFFG	1	0.0	272.0	0.8	65.0	6.5
XRFGA	1	0.0	272.0	0.8	104.0	2.6
XADNA	1	0.0	272.0	0.8	65.0	6.5
XADDS	1	0.0	0.0	0.0	0.0	0.0
XCCFG	1	0.0	296.9	2.3	0.0	0.0
XCCGA	1	0.0	296.9	2.3	93.7	6.9
XADGO	1	0.0	0.0	0.0	0.0	0.0
XCCGO	1	0.0	296.5	0.9	0.0	0.0
XADRS	1	0.0	0.0	0.0	0.0	0.0
XHTRS	1	0.0	355.9	3.8	0.0	0.0
XBU	1	0.0	0.0	0.0	91.8	199.2

Table 41: Data for stored components for the solution to the case example.

Component	Product	Time_ period	Volume
XADFG	FG	1	2.3
XADGA	PG	1	20.8
XADGA	RG	1	0.0
XRFFG	FG	1	2.6
XRFGA	PG	1	16.1
XRFGA	RG	1	0.0
XADNA	PG	1	1.1
XADNA	RG	1	0.0
XADNA	DS	1	0.0
XADDS	DS	1	0.0
XCCFG	FG	1	5.5
XCCGA	PG	1	10.7
XCCGA	RG	1	0.0
XADGO	DS	1	0.0
XADGO	FO	1	0.0
XCCGO	DS	1	0.0
XCCGO	FO	1	3.9
XADRS	FO	1	0.0
XHTRS	FO	1	36.7
XBU	PG	1	0.6
XBU	RG	1	0.0

Table 42: Blending information for the solution to the case example.

The system has also generated postscript files for easy visualization of the solution. One shows the volume flow, see Figure 4, and others show the different qualities through the refinery process. Figure 5 shows the density levels, Figure 6 shows the octane levels, Figure 7 shows the Vapor levels and Figure 8 shows the sulphur levels.

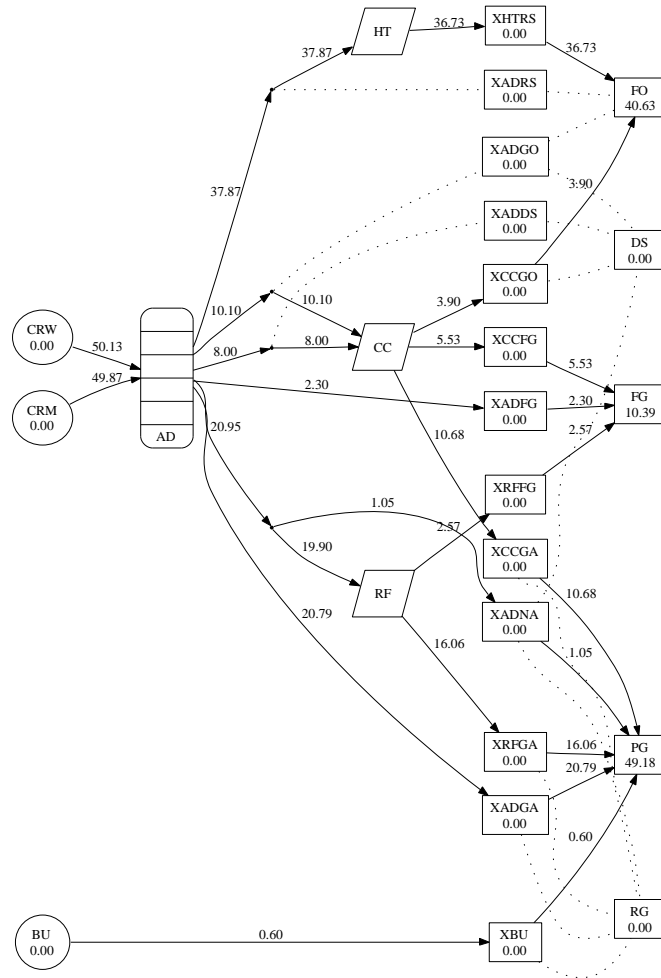

Figure 4: The volumes for the solution to the case example presented in a network flow.

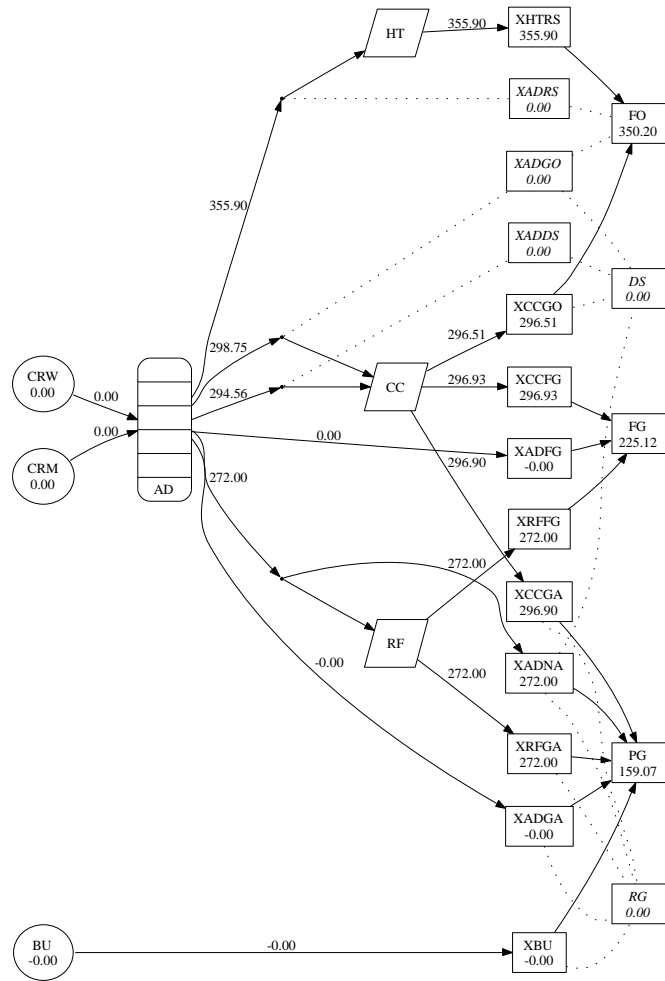

Figure 5: The density levels for the solution to the case example.

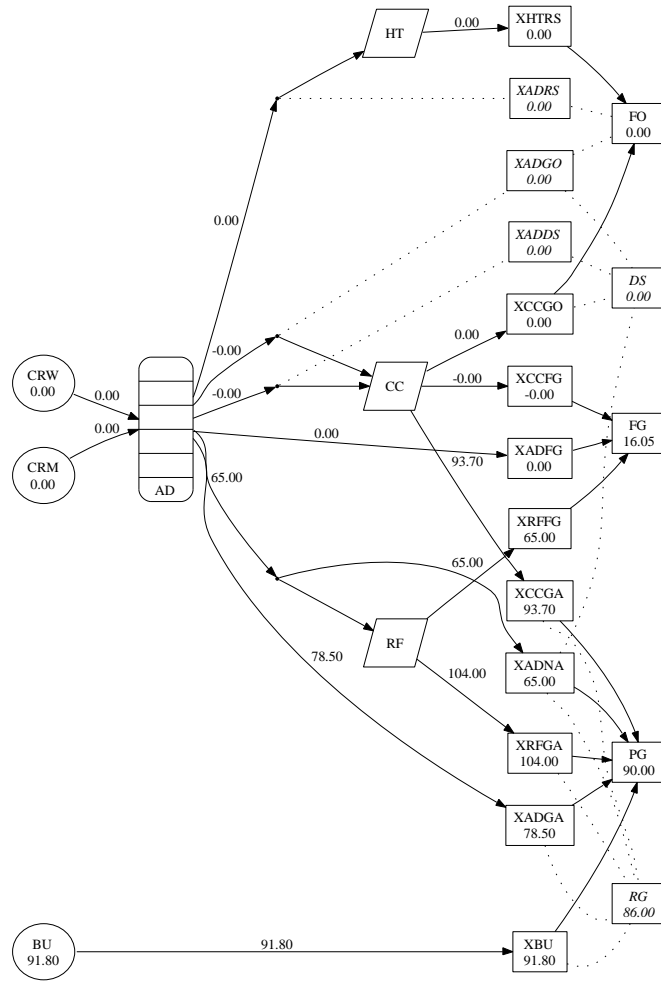

Figure 6: The octane levels for the solution to the case example.

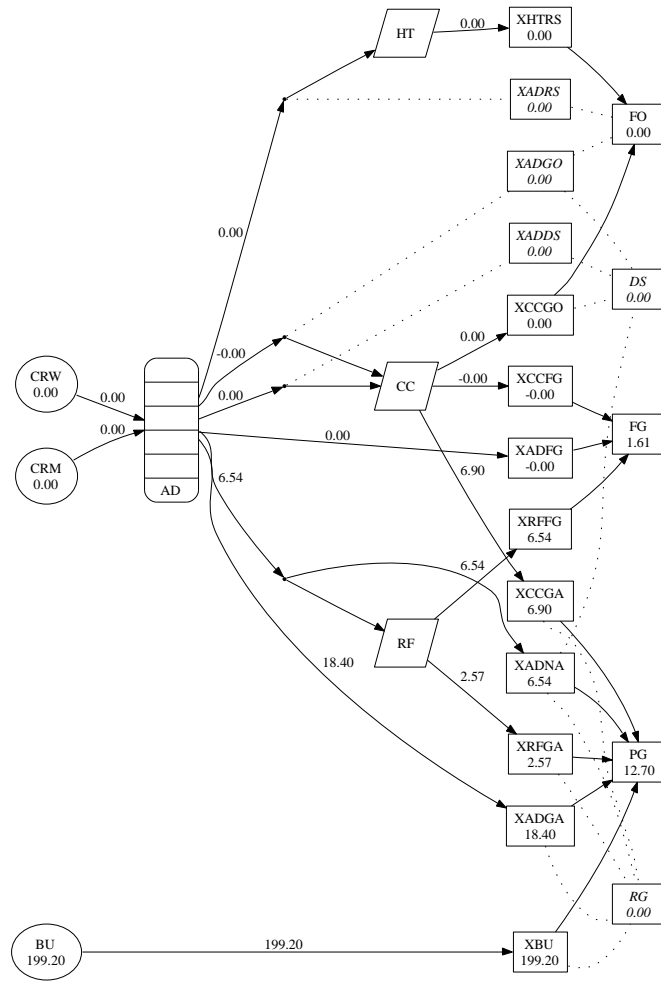

Figure 7: The vapor levels for the solution to the case example.

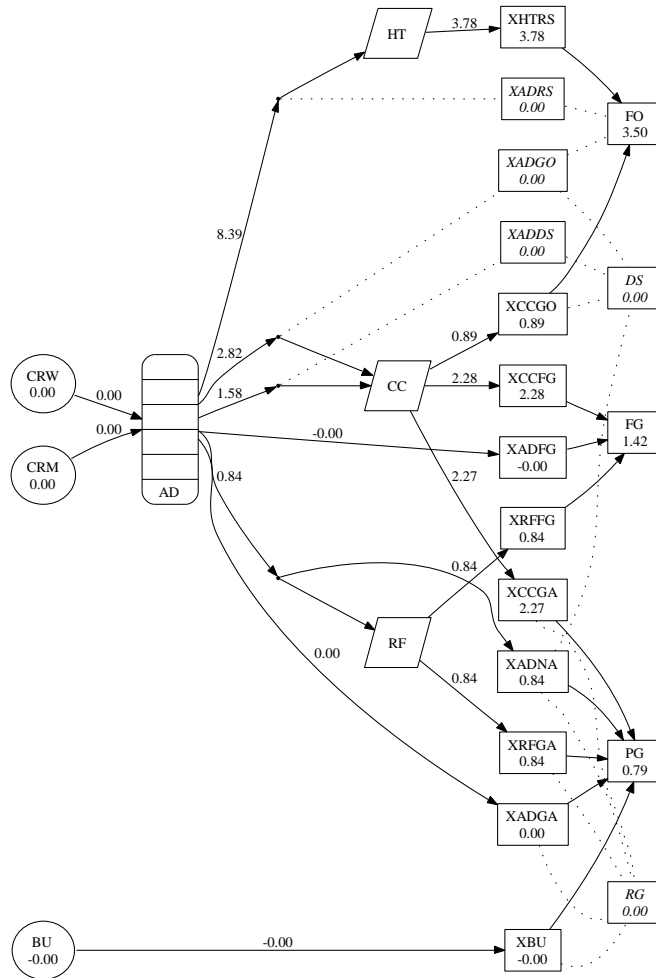

Figure 8: The sulphur levels for the solution to the case example.

References

- [1] J. Aronofsky, J. Dutton, and M. Tayyabkhan. *Managerial Planning with Linear Programming. Proess Industry Applications*, John Wiley & Sons, 1978.
- [2] D. Bredström, P. Flisberg and M. Rönnqvist. *Refinery production planning - model and solution method*. SNF Report No. 24/08, Bergen, Norway, 2008.
- [3] J.-P. Favennec. *Refinery Operation and Management. Petroleum refining vol. 5*, Editions Technip, Paris, 2001.
- [4] M. Rönnqvist, P. Flisberg, and S. Nilsson. *Billerud optimizes its bleaching process using online optimization*. To appear in *Interfaces*.
- [5] R. Fourer, D.M. Gay, and B.W. Kernighan. *AMPL: A Modeling Language for Mathematical Programming*, Second Edition, Thomson, Brooks/Cole, 2003.
- [6] J.H. Gary and G.E. Handwerk, *Petroleum Refining Technology and Economics*. Foruth Edition, Marcel Dekker, Inc., New York, 2001.
- [7] B.A. Murtagh and M.A. Saunders. *MINOS 5.5 USER'S GUIDE*. Technical report, Systems Optimization Laboratory. Department of Operatoins Research, Stanford University, Stanford, California 94305-4022, USA, 1998. Technical Report SOL 83-20R.
- [8] S. Parkash. *Refining Processes Handbook*, ISBN-13: 978-0-7506-7721-9, Elsevier, 2003.